



alcapipe

Product catalogue 2023

Piping systems

FROM FOUNDING OF THE COMPANY TO THE TOP IN THE INDUSTRY

EXPORT WORLDWIDE

Our export department is in daily contact with the customers from all over the world. 70% of our production is delivered to 40 countries on four continents. Our quality and innovative products help to improve life around the planet.

THE LEADER AMONG THE NEW GENERATION OF POLYPROPYLENE PROCESSORS PP-RCT

FV - Plast is the largest manufacturer of PP-RCT pipes and fittings in Central and Eastern Europe with the widest range of PP-RCT pipes in four product lines. In addition to this modern raw material, we also buy in Europe other high-quality plastic granules, brass and other raw materials for our products.

FV - Plast, as was founded in 1990 with the aim of producing quality plastic piping systems for water distribution and heating. After more than 30 years of production, development and innovation, it now processes polyethylenes, polypropylenes and polybutylenes into many types of pipes, fittings and accessories. Gradually, it reached the top of Czech manufacturers and suppliers of plumbing installation systems, floor heating and ceiling cooling systems, equipment for heat pumps and the use of geothermal energy.





COMFORT

UNIQUE INVISIBLE FV COMFORT SYSTEM

Offer of comprehensive system solutions, this is a new direction of production of the company FV - Plast. The unique invisible FV COMFORT system combines underfloor heating, ceiling cooling and controlled ventilation so that our products make your life as easy as possible. Our work is done perfectly when it is inconspicuous to customers.



WORLD QUALITY FROM CZECH HANDS

Thanks to the skill of our technicians and the sophistication of the latest world technologies, we produce first-class pipes and fittings that will withstand all world markets. The quality is proven by the certificates of many world testing laboratories. The quality management system, together with internal tests of raw materials and finished products in our own, modern laboratory allows us to provide our products with up to 20 years of warranty.



TOP TECHNOLOGIES

Our production is fully automated and we are constantly improving it. Based on the latest knowledge from around the world, we develop state-of-the-art equipment for the production of our products. In order to stay at the top of the world, we invest in research into modern technologies and use cooperation with research and technology centers in the Czech Republic. We are the only manufacturers of PE-RT and AL-PERT multilayer pipes in the Czech Republic.



EXPLANATIONS OF GRAPHIC SYMBOLS

Dimension	Unit	Quantity in a large package	Quantity in a small package	Weight * [kg/unit]	Volume [dm ³ /unit]

Potable water	Heating, Cooling	Pools	Chemical industry	Shipbuilding	Infrastructure	Industrial cooling	Utility water	Geothermy



		Pipes and fittings in gray colour
		Pipes and fittings in green colour

Note: Typographical errors reserved.
 * Actual weight may slightly vary within the tolerances specified in the relevant standards.

CONTENT

AQUA	
Pipes for welding	14
All-plastic FV PPR fittings	16
Combined fittings	23
Shut-off valves	32
FV PP-RCT butt welding fittings	36
Tools for FV AQUA PPR and PP-RCT system	40
Assembly instructions for FV AQUA PPR and PP-RCT	47
FV MULTI pipes	53
FV M-PRESS brass press fittings	54
Tools for FV MULTI	61
Assembly instructions for FV AQUA connection with press fittings	62
Accessories	63
COMFORT	
Heating	
Heating system pipes	72
System floorboards for heating	73
Manifolds	78
Valves and thermometers	78
Mixing sets	79
Cabinets	79
Accessories	80
Control	81
Couplings – fittings	82
Accessories	83
Assembly instructions for underfloor heating	84
Cooling	
Cooling system pipes	89
System ceiling tiles for cooling	89
Manifolds	90
Fittings	92
Control	93
Accessories	95
Accessories	95
Assembly instructions for cooling	96
ENERGEO	
Distribution shafts	100
Distribution cabinets	102
Wall distributor	102
Accessories for distribution shafts	103
Fittings	103
Probes	105
Pipes for flat collectors made of HDPE 100 RC	107
Tools	108
Assembly instructions for FV ENERGEO	109
INFRA	
FV INFRA pipes	114
Assembly instructions for FV INFRA	116
Index	120

OVERVIEW OF THE USE OF FV ELEMENTS

- 
AQUA
- 
ENERGEO
- 
COMFORT
- 
INFRA

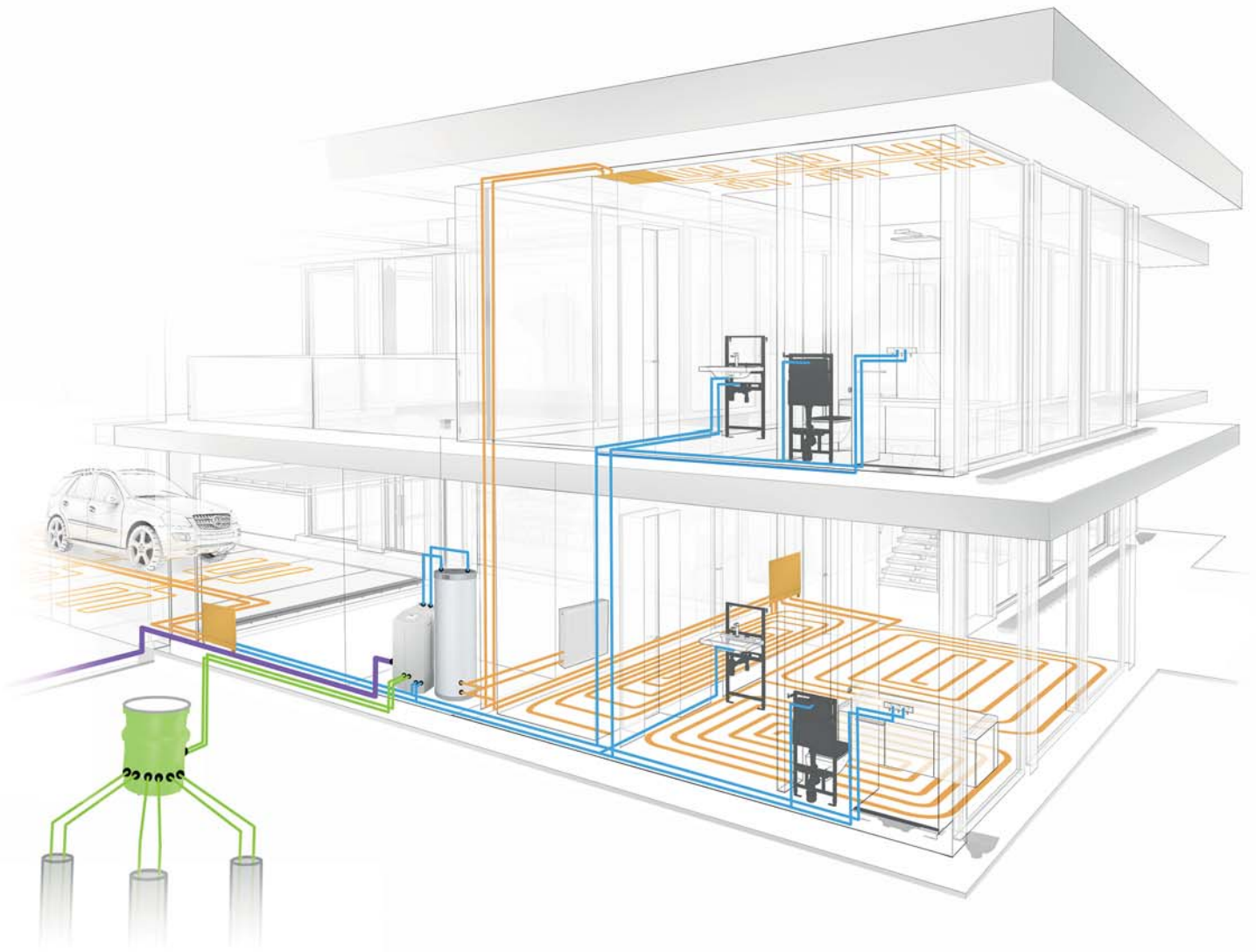

The portfolio of FV - Plast, as is divided into four system groups:

- AQUA system for complete solutions of water and heating distributions in residential and industrial construction
- COMFORT system for underfloor, wall and ceiling heating and cooling
- ENERGEO system solution of the primary part of geothermal heat sources
- INFRA pipes for infrastructure distribution

		Cold water	Air conditioning, cooling water	Hot water	Floor heating	Low temperature heating distribution	High temperature heating distribution	Air distribution	Earth probes and collectors to heat pumps	Water supply and connections
FQJA	FV PPR CLASSIC S2,5 SDR6 (PN 20)		✓	✓	✓	✓		✓		
	FV PPR FASER S2,5 SDR6 (PN 20)	✓		✓		✓	✓	✓		
	FV PP-RCT UNI	✓	✓	✓	✓	✓		✓		
	FV PP-RCT HOT	✓		✓	✓	✓		✓		
	FV PP-RCT FASER COOL	✓		✓				✓		
	FV PP-RCT FASER HOT			✓		✓	✓	✓		
	FV MULTIPERT-AL	✓	✓	✓	✓	✓	✓			
	Fittings FV PPR a FV PP-RCT	✓	✓	✓	✓	✓	✓	✓		
	Fittings FV M-PRESS	✓	✓	✓	✓	✓	✓			
COMFORT	FV MULTIPERT-5	✓	✓	✓	✓	✓	✓			
	FV MULTIPERT-AL	✓	✓	✓	✓	✓	✓			
	FV COOLING PE-RT	✓	✓	✓	✓	✓	✓			
	FV COOLING PB	✓	✓							
	FV ENERGEO GH								✓	
ENERGEO	FV ENERGEO CP								✓	
	FV HDPE								✓	
INFRA	FV HDPE-RC									✓

Explanations: ✓ Preferred area of application
 ✓ Suitable application area

...more than pipes

COMFORT – HEATING AND COOLING ALL IN ONE

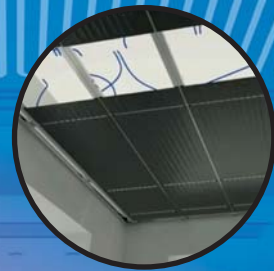

The pipes are integrated into
the floor and ceiling

Universal for all constructions
and surfaces



COMPLEX SOLUTION

We offer a unique system of floor heating and ceiling cooling for optimal thermal comfort in family houses, apartments and commercial spaces.

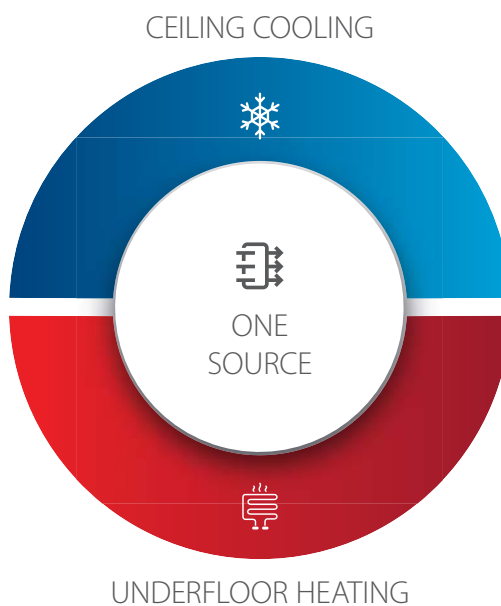

SILENT

ECONOMICAL

COMFORTABLE

HEALTHIER

IMPLEMENTATION SUPPORT

- We will prepare a project for your customers free of charge
- We will supply all system components, including distributions
- We offer training and support during installation
- Assembly is easy and fast
- The system runs smoothly, ie minimal maintenance requirements

20
YEAR WARRANTY

50
YEARS LIFETIME

COMFORT

A NEW GENERATION OF PP-RCT DISTRIBUTION

37% HIGHER FLOW RATE PROFILE COMPARED TO PPR PIPES

The new generation of FV PP-RCT pipes uses the excellent properties of PP-RCT material in all-plastic and multilayer pipes. The PP-RCT material is able to achieve the same or better pressure and temperature resistance as PPR pipes with a lower wall thickness.



Proven method of joining by polyfusion welding as PPR



Higher operating temperature range for a given application "HOT" or "COOL"



3x lower thermal expansion than PPR pipes (for FV PP-RCT FASER)



More than 50 years of longevity

COMPATIBILITY WITH OLDER DISTRIBUTION PPR CLASSIC

You can connect PP-RCT pipes to older PPR CLASSIC distribution lines without any problems

OLDER PROFILES FV PPR CLASSIC

4TH GENERATION OF PIPES FV PP-RCT

CLASSIC PN16	>	—	FV PP-RCT UNI
CLASSIC PN20	>	—	FV PP-RCT HOT
FASER PN16	>	—	FV PP-RCT FASER COOL
FASER PN20	>	—	FV PP-RCT FASER HOT



* compared to PPR pipes PN20

** calculated value for PP-RCT HOT PN26

+37 %
FLOW RATE

+ 20 % flow rate profile

PPR CLASSIC

PP-RCT

SDR 9 S 4 CSN EN ISO 15874 (Class 1/8 bar, 2/8 bar) skz. n. 677 oxygen barrier dn 4726 01.01.21 1025 05 Made in EU (Cast Republic)

FV Plast PP-RCT HOT SDR 7,4 S 3,2 csn EN ISO 15874 (Class 1/10 bar, 2/10 bar) skz. n. 677 oxygen barrier dn 4726 01.01.21 1025 05 Made in EU

FV Plast PP-RCT FASER COOL PP-RCT/PP-RCT+GF/PP-RCT SDR 11 S 5 CSN EN ISO 15874 (C)

FV Plast PP-RCT FASER HOT PP-RCT



The widest range for plumbing installations made of polypropylene 4th generation





AQUA

- Pipes for welding
- All-plastic FV PPR fittings
- Combined fittings
- Shut-off valves
- FV PP-RCT butt welding fittings
- Tools for FV AQUA PPR and PP-RCT system
- Assembly instructions for FV AQUA PPR and PP-RCT
- FV MULTI pipes
- FV M-PRESS brass press fittings
- Tools for FV MULTI
- Assembly instructions for FV AQUA connection with press fittings
- Accessories

WELDING PIPES

FV PP-RCT UNI

System: **AQUA**
 Material: PP-RCT
 Standard: ČSN EN ISO 15874

Note: Suitable for water distribution to 60°C and compressed air. For application in systems to 20°C/1,6MPa - 60°C/0,8MPa.

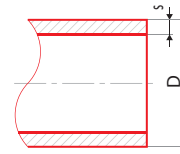

Icon	⊕	⊞	⊞	⊞	dm ²	# ●	# ●	# ●	D [mm]	s [mm]	SDR (S)	l [m]	
	m	160			0,095	0,28	AA110016004	BA110016004		16	2,2	7,4 (3,2)	4
	m	100			0,127	0,44	AA110020004	BA110020004		20	2,3	9 (4)	4
	m	60			0,191	0,73	AA110025004	BA110025004		25	2,8	9 (4)	4
	m	40			0,333	1,10	AA110032104	BA110032104		32	3,6	9 (4)	4
	m	24			0,412	1,83	AA110040004	BA110040004		40	3,7	11 (5)	4
	m	16			0,638	2,75	AA110050004	BA110050004		50	4,6	11 (5)	4
	m	12			1,010	4,07	AA110063004	BA110063004		63	5,8	11 (5)	4
	m	8			1,410	5,50	AA110075004	BA110075004		75	6,8	11 (5)	4
	m	4			2,030	9,17	AA110090004	BA110090004		90	8,2	11 (5)	4
	m	4			3,010	10,31	AA110110004	BA110110004		110	10,0	11 (5)	4
	m	4			3,910	12,27		BA110125004		125	11,4	11 (5)	4
	m	4			6,380	20,10		BA110160004		160	14,6	11 (5)	4
	m	4			9,950	31,40		BA110200004		200	18,2	11 (5)	4
	m	4			15,500	49,06		BA110250004		250	22,7	11 (5)	4

FV PP-RCT HOT

System: **AQUA**
 Material: PP-RCT
 Standard: ČSN EN ISO 15874

Note: Suitable for hot water distribution. For application in systems 20°C/2,0MPa - 70°C/1,0MPa.

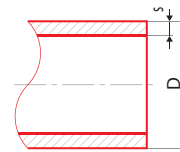

Icon	⊕	⊞	⊞	⊞	dm ²	# ●	# ●	# ●	D [mm]	s [mm]	SDR (S)	l [m]	
	m	100			0,148	0,44	AA112020004	BA112020004		20	2,8	7,4 (3,2)	4
	m	60			0,230	0,73	AA112025004	BA112025004		25	3,5	7,4 (3,2)	4
	m	40			0,370	1,10	AA112032004	BA112032004		32	4,4	7,4 (3,2)	4
	m	24			0,575	1,83	AA112040004	BA112040004		40	5,5	7,4 (3,2)	4
	m	16			0,896	2,75	AA112050004	BA112050004		50	6,9	7,4 (3,2)	4
	m	12			1,410	4,07	AA112063004	BA112063004		63	8,6	7,4 (3,2)	4
	m	8			2,010	5,50	AA112075004	BA112075004		75	10,3	7,4 (3,2)	4
	m	4			2,870	9,17	AA112090004	BA112090004		90	12,3	7,4 (3,2)	4
	m	4			4,300	10,31	AA112110004	BA112110004		110	15,1	7,4 (3,2)	4
	m	4			5,530	12,27		BA112125004		125	17,1	7,4 (3,2)	4

FV PP-RCT FASER HOT

System: **AQUA**
 Material: PP-RCT
 Standard: ČSN EN ISO 15874

Note: Suitable for hot water distribution. For application in systems 20°C/2,0MPa - 70°C/1,0MPa to D=125 and 20°C/1,6MPa - 70°C/0,8MPa to D=160 even larger.

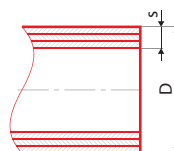

□	⊕	⊞	⊞	⊞	dm ³	# ●	# ●	# ●	D [mm]	s [mm]	SDR (S)	l [m]	
20 × 2,8	m	100			0,151	0,44	AA113020004	BA113020004		20	2,8	7,4 (3,2)	4
25 × 3,5	m	60			0,232	0,73	AA113025004	BA113025004		25	3,5	7,4 (3,2)	4
32 × 3,6	m	40			0,340	1,10	AA113032004	BA113032004		32	3,6	9 (4)	4
40 × 4,5	m	24			0,513	1,83	AA113040004	BA113040004		40	4,5	9 (4)	4
50 × 5,6	m	16			0,746	2,75	AA113050004	BA113050004		50	5,6	9 (4)	4
63 × 7,1	m	12			1,190	4,07	AA113063004	BA113063004		63	7,1	9 (4)	4
75 × 8,4	m	8			1,700	5,50	AA113075004	BA113075004		75	8,4	9 (4)	4
90 × 10,1	m	4			2,400	9,17	AA113090004	BA113090004		90	10,1	9 (4)	4
110 × 12,3	m	4			3,400	10,31	AA113110004	BA113110004		110	12,3	9 (4)	4
125 × 14,0	m	4			4,480	12,27		BA113125004		125	14,0	9 (4)	4
160 × 14,6	m	4			6,775	20,10		BA113160004		160	14,6	11 (5)	4
200 × 18,2	m	4			10,640	31,40		BA113200004		200	18,2	11 (5)	4
250 × 22,7	m	4			16,610	49,06		BA113250004		250	22,7	11 (5)	4
125 × 14,0	m	6			4,480	12,27		BA113125006		125	14,0	9 (4)	6
160 × 14,6	m	6			6,775	20,10		BA113160006		160	14,6	11 (5)	6
200 × 18,2	m	6			10,640	31,40		BA113200006		200	18,2	11 (5)	6
250 × 22,7	m	6			16,610	49,06		BA113250006		250	22,7	11 (5)	6

FV PPR CLASSIC - PIPE IN COIL

System: **AQUA**
 Material: PP-R
 Standard: ČSN EN ISO 15874

Note: A pipe packed in 200-m rolls suitable for floor heating systems.

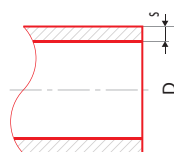

□	⊕	⊞	⊞	⊞	dm ³	# ●	# ●	# ●	D [mm]	s [mm]	l [m]	
16 × 2,0	m	200			0,09	2,01	AA103016200	BA103016200		16	2,00	200
20 × 2,0	m	200			0,11	3,14	AA103020200	BA103020200		20	2,00	200
20 × 2,8	m	200			0,15	3,14	AA102020200	BA102020200		20	2,80	200
20 × 3,4	m	200			0,17	3,14	AA101020200	BA101020200		20	3,40	200

ALL-PLASTIC PPR FITTINGS

FV PPR compensation pipe

System: **AQUA**
 Material: PP-R
 Standard: ČSN EN ISO 15874

Note: Preventing deformations in a piping system caused by thermal expansion.

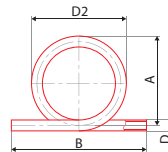

Icon	⊕	⊞	⊞	⊞	dm ³	# ●	# ●	# ●	D [mm]	D2 [mm]	A [mm]	B [mm]
16	pcs	10	1	0,07	1,60	AA232016000	BA232016000		16	188,0	180	290
20	pcs	6	1	0,11	1,60	AA232020000	BA232020000		20	210,0	200	300
25	pcs	5	1	0,21	3,20	AA232025000	BA232025000		25	217,5	205	370
32	pcs	4	1	0,43	8,00	AA232032000	BA232032000		32	231,0	215	400
40	pcs	2	1	0,67	8,00	AA232040000	BA232040000		40	295,0	275	420

FV PPR crossover

System: **AQUA**
 Material: PP-R
 Standard: ČSN EN ISO 15874

Note: For pipe crossing in case of branching, connection to a fitting.

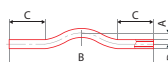

Icon	⊕	⊞	⊞	⊞	dm ³	# ●	# ●	# ●	D [mm]	A [mm]	B [mm]	C [mm]
16	pcs	180	1	0,03	0,24	AA233016000	BA233016000		16	35	380	100
20	pcs	100	1	0,07	0,32	AA233020000	BA233020000		20	42	400	110
25	pcs	50	1	0,09	0,64	AA233025000	BA233025000		25	30	400	100
32	pcs	35	1	0,16	0,80	AA233032000	BA233032000		32	35	400	90
40	pcs	20	1	0,33	1,60	AA233040000	BA233040000		40	35	400	90

FV PPR crossover with socket

System: **AQUA**
 Material: PP-R
 Standard: ČSN EN ISO 15874

Note: For pipe crossing in case of branching, connection to a pipe.

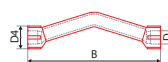

Icon	⊕	⊞	⊞	⊞	dm ³	# ●	# ●	# ●	D4 [mm]	B [mm]	C [mm]
20	pcs	100	1	0,07	0,24	AA246020000	BA246020000		31	188	20
25	pcs	50	1	0,09	0,32	AA246025000	BA246025000		37	198	25

FV PPR crossover with socket

System: **AQUA**
 Material: PP-R
 Standard: ČSN EN ISO 15874

Note: For pipe crossing in case of branching, connection to a pipe.

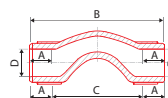

Icon	⊕	⊞	⊞	⊞	dm ³	# ●	# ●	# ●	D [mm]	A [mm]	B [mm]	C [mm]
20	pcs	160	10	0,029	0,117	AA246020001	BA246020001		20	14,5	88	59
25	pcs	100	5	0,044	0,187	AA246025001	BA246025001		25	16	97	65

FV PPR elbow 90°

System: **AQUA**
 Material: PP-R
 Standard: ČSN EN ISO 15874

Note: A simple, reliable fitting for changing the pipeline direction.

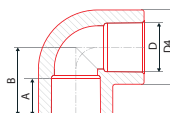

Code	Unit	Quantity	Weight	Volume	Material	Product Code	Product Code	Product Code	D [mm]	D4 [mm]	A [mm]	B [mm]
16	pcs	200	50	0,01	0,05	AA202016000	BA202016000		16	24	13,3	22,0
20	pcs	300	50	0,02	0,07	AA202020000	BA202020000		20	29	14,5	25,5
25	pcs	150	25	0,03	0,12	AA202025000	BA202025000		25	37	16,0	29,0
32	pcs	80	10	0,06	0,24	AA202032000	BA202032000		32	46	18,1	34,2
40	pcs	40	4	0,11	0,53	AA202040000	BA202040000		40	60	20,5	41,5
50	pcs	30	2	0,19	0,96	AA202050000	BA202050000		50	73	23,5	48,5
63	pcs	10	2	0,37	1,92	AA202063000	BA202063000		63	94	27,4	59,2
75	pcs	6	1	0,52	3,20	AA202075000	BA202075000		75	108	31,0	67,7
90	pcs	6	1	0,79	4,80	AA202090000	BA202090000		90	126	35,5	78,4
110	pcs	3	1	1,38	5,50	AA202110000	BA202110000		110	151	41,5	98,0
125	pcs	1	1	2,05	7,04		BA202125000		125	165	40	124

FV PPR elbow 90° reduced

System: **AQUA**
 Material: PP-R
 Standard: ČSN EN ISO 15874

Note: A simple, reliable fitting for changing the pipeline direction and dimension.

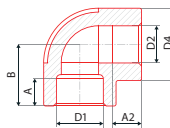

Code	Unit	Quantity	Weight	Volume	Material	Product Code	Product Code	Product Code	D [mm]	D2 [mm]	D4 [mm]	A [mm]	B [mm]
25	pcs	50	1	0,09	0,32	AA211025020	BA211025020	WA211025020	25	20	36,3	16	32,2

FV PPR elbow 45°

System: **AQUA**
 Material: PP-R
 Standard: ČSN EN ISO 15874

Note: A simple, reliable fitting for changing the pipeline direction.

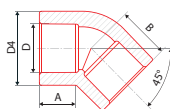

Code	Unit	Quantity	Weight	Volume	Material	Product Code	Product Code	Product Code	D [mm]	D4 [mm]	A [mm]	B [mm]
16	pcs	200	50	0,01	0,03	AA203016000	BA203016000		16	24,3	13,3	17,5
20	pcs	400	50	0,02	0,07	AA203020000	BA203020000		20	29,1	14,5	19,5
25	pcs	200	25	0,03	0,12	AA203025000	BA203025000		25	36,8	16,0	22,0
32	pcs	80	10	0,06	0,24	AA203032000	BA203032000		32	46,0	18,1	25,5
40	pcs	30	10	0,11	0,53	AA203040000	BA203040000		40	59,0	20,5	30,0
50	pcs	28	4	0,19	0,96	AA203050000	BA203050000		50	74,85	23,5	34,5
63	pcs	10	2	0,37	1,92	AA203063000	BA203063000		63	94,0	27,4	44,5
75	pcs	6	1	0,52	3,20	AA203075000	BA203075000		75	99,0	30,0	48,0
90	pcs	6	1	0,79	4,80	AA203090000	BA203090000		90	120	33,0	54,1
110	pcs	4	1	1,38	5,50	AA203110000	BA203110000		110	148	37,0	69,0
125	pcs	2	1	1,40	7,04		BA203125000		125	165	40,0	77,0

FV PPR elbow 90° internal / external

System: **AQUA**
 Material: PP-R
 Standard: ČSN EN ISO 15874

Note: A simple, reliable fitting for changing the pipeline direction.

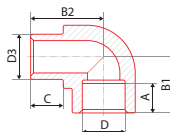

Code	Unit	Quantity	Weight	Volume	Material	Product Code	Product Code	Product Code	D, D3 [mm]	A [mm]	B1 [mm]	B2 [mm]	C [mm]
20	pcs	400	50	0,01	0,05	AA204020000	BA204020000		20	14,5	25,6	29,0	14,5
25	pcs	200	25	0,03	0,14	AA204025000	BA204025000		25	16,0	31,5	35,4	14,8
32	pcs	100	20	0,07	0,22	AA204032000	BA204032000		32	18,0	36,5	42,2	16,0

FV PPR elbow 45° internal / external

System: **AQUA**
 Material: PP-R
 Standard: ČSN EN ISO 15874

Note: A simple, reliable fitting for changing the pipeline direction.

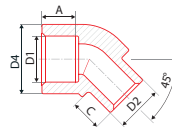

Objekt	Symbol	Skupina	Podskupina	Objem	hm ³	# ●	# ●	# ●	D1 [mm]	D2 [mm]	D4 [mm]	A [mm]	C [mm]
16	pcs	280	20	0,010	0,04	AA205016000	BA205016000		16	16	24,2	13,3	12,5
20	pcs	200	20	0,020	0,07	AA205020000	BA205020000		20	20	29,5	14,5	14,8
25	pcs	100	10	0,026	0,07	AA205025000			25	25	36,3	18,3	17,3

FV PPR elbow 90° for wall mounting welding

System: **AQUA**
 Material: PP-R
 Standard: ČSN EN ISO 15874

Note: Fixing fitting with tap connector for mixers.

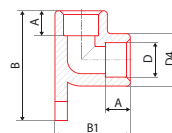

Objekt	Symbol	Skupina	Podskupina	Objem	hm ³	# ●	# ●	# ●	D [mm]	D4 [mm]	A [mm]	B [mm]	B1 [mm]
20	pcs	60	10	0,02	0,16	AA206020000	BA206020000		20	30,2	14,5	48,5	43,5
25	pcs	40	10	0,04	0,32	AA206025000	BA206025000		25	35,3	16,0	76,2	51,0

FV PPR reduction internal / external

System: **AQUA**
 Material: PP-R
 Standard: ČSN EN ISO 15874

Note: A simple, reliable fitting for dimension change of pipeline.

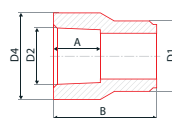

Objekt	Symbol	Skupina	Podskupina	Objem	hm ³	# ●	# ●	# ●	D1 [mm]	D2 [mm]	D4 [mm]	A [mm]	B [mm]
20 x 16	pcs	400	50	0,01	0,02	AA210020016	BA210020016		20	16	24,0	13,3	28,4
25 x 16	pcs	300	50	0,01	0,03	AA210025016	BA210025016		25	16	30,1	13,3	31,8
25 x 20	pcs	400	50	0,01	0,05	AA210025020	BA210025020		25	20	30,1	14,5	34,2
32 x 20	pcs	300	10	0,03	0,13	AA210032020	BA210032020		32	20	33,8	14,5	35,4
32 x 25	pcs	200	10	0,03	0,12	AA210032025	BA210032025		32	25	36,0	16,0	38,0
40 x 20	pcs	180	10	0,02	0,13	AA210040020	BA210040020		40	20	40,0	14,5	41,5
40 x 25	pcs	180	10	0,03	0,16	AA210040025	BA210040025		40	25	37,9	16,0	43,5
40 x 32	pcs	120	10	0,04	0,24	AA210040032	BA210040032		40	32	47,3	18,1	50,7
50 x 32	pcs	80	10	0,05	0,27	AA210050032	BA210050032		50	32	50,3	18,1	50,6
50 x 40	pcs	60	10	0,05	0,30	AA210050040	BA210050040		50	40	60,5	20,5	49,8
63 x 32	pcs	60	10	0,07	0,32	AA210063032	BA210063032		63	32	48,2	18,1	43,5
63 x 40	pcs	50	10	0,08	0,40	AA210063040	BA210063040		63	40	59,7	20,5	52,0
63 x 50	pcs	40	10	0,12	0,60	AA210063050	BA210063050		63	50	74,3	23,5	62,0
75 x 40	pcs	20	5	0,12	0,60	AA210075040	BA210075040		75	40	93,2	20,5	64,5
75 x 50	pcs	20	5	0,12	0,80	AA210075050	BA210075050		75	50	93,2	23,5	57,5
75 x 63	pcs	24	2	0,21	1,37	AA210075063	BA210075063		75	63	93,2	27,4	72,2
90 x 63	pcs	25	1	0,24	0,98	AA210090063	BA210090063		90	63	94,8	27,4	70,8
90 x 75	pcs	20	1	0,27	2,40	AA210090075	BA210090075		90	75	106,0	31,0	73,2
110 x 75	pcs	1	1	0,30	1,32	AA210110075	BA210110075		110	75	125,8	30,0	64,0
110 x 90	pcs	1	1	0,50	2,80	AA210110090	BA210110090		110	90	125,8	35,5	91,7
125 x 110*	pcs	1	1	1,03	3,52		BA210125110		125	110	134,6	85,0	225

* Green reduction 125 x 110 for butt welding

FV PPR three-way elbow

System: **AQUA**
 Material: PP-R
 Standard: ČSN EN ISO 15874

Note: A simple, reliable fitting for branching the pipeline.

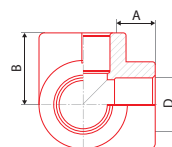

Objekt	Symbol	Skupina	Podskupina	Objem	hm ³	# ●	# ●	# ●	D [mm]	A [mm]	B [mm]
20	pcs	50	10	0,03	0,13	AA242020000	BA242020000		20	14,5	26,8
25	pcs	50	10	0,04	0,17	AA242025000	BA242025000		25	16,0	29,5
32	pcs	20	5	0,05	0,20	AA242032000	BA242032000		32	18,0	35,0

FV PPR socket

System: **AQUA**
 Material: PP-R
 Standard: ČSN EN ISO 15874

Note: A simple, reliable fitting for pipe connection.

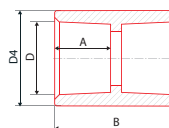

Icon	Symbol	Grid 1	Grid 2	Weight	Volume	Code 1	Code 2	Code 3	D1 [mm]	D4 [mm]	A [mm]	B [mm]
	pcs	300	50	0,01	0,03	AA201016000	BA201016000		16	24,10	13,3	29,6
	pcs	400	50	0,01	0,05	AA201020000	BA201020000		20	29,10	14,5	32,0
	pcs	200	25	0,03	0,10	AA201025000	BA201025000		25	36,70	16,0	35,5
	pcs	100	10	0,04	0,19	AA201032000	BA201032000		32	46,20	18,1	38,3
	pcs	100	10	0,06	0,24	AA201040000	BA201040000		40	59,50	20,5	45,4
	pcs	40	4	0,11	0,60	AA201050000	BA201050000		50	73,00	23,5	50,8
	pcs	30	2	0,19	0,87	AA201063000	BA201063000		63	90,30	27,4	58,5
	pcs	15	1	0,27	1,92	AA201075000	BA201075000		75	108,5	31,0	66,5
	pcs	10	1	0,42	2,40	AA201090000	BA201090000		90	127,3	35,5	73,6
	pcs	4	1	0,67	2,80	AA201110000	BA201110000		110	152,7	41,5	87,2
	pcs	1	1	0,75	2,45		BA201125000		125	165,0	40,0	90,0

PPR reduction

System: **AQUA**
 Material: PP-R
 Standard: ČSN EN ISO 15874

Note: A simple, reliable fitting for dimension change of pipeline.

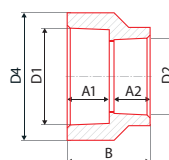

Icon	Symbol	Grid 1	Grid 2	Weight	Volume	Code 1	Code 2	Code 3	D1 [mm]	D2 [mm]	D4 [mm]	A1/A2 [mm]	B [mm]			
	pcs	200	50	0,01	0,05	AA209020016	BA209020016		20	16	29,0	14,5/13,3	33,0			
	pcs	300	50	0,02	0,11	AA209025020	BA209025020		25	20	36,7	16/14,5	34,3			
the equivalent multifunctional reduction AA210032025 can also be ordered																
	pcs	180	10	0,02	0,13	AA209032020	BA209032020		32	20	46,3	18,1/14,5	35,0			
	pcs	150	10	0,03	0,13	AA209032025	BA209032025		32	25	47,1	18,1/16	38,0			
	pcs					Please order equivalent reduction outside / outside 63 x 32										
	pcs	40	4	0,09	0,60	AA209050040	BA209050040		50	40		23,5/20,5	47,0			
	pcs	24	2	0,17	0,80	AA209063050	BA209063050		63	50	93,2	27,4/23,5	54,0			

FV PPR bend 90° int/ext

System: **AQUA**
 Material: PP-R
 Standard: ČSN EN ISO 15874

Note: For change of direction with lower pressure losses.

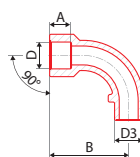

Icon	Symbol	Grid 1	Grid 2	Weight	Volume	Code 1	Code 2	Code 3	D1 [mm]	D3 [mm]	A [mm]	B [mm]
	pcs	100	10	0,03	0,12	AA241020000			20	20	13	56

FV PPR bend 90°

System: **AQUA**
 Material: PP-R
 Standard: ČSN EN ISO 15874

Note: For change of direction with lower pressure losses.

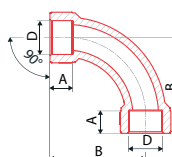

Icon	Symbol	Grid 1	Grid 2	Weight	Volume	Code 1	Code 2	Code 3	D [mm]	A [mm]	B [mm]
	pcs	125	1	0,024	0,144	AA259020000	BA259020000		20	14,5	56
	pcs	100	1	0,049	0,216	AA259025000	BA259025000		25	16	68,5
	pcs	50	1	0,100	0,432	AA259032000	BA259032000		32	18	85,5
	pcs	25	1	0,193	0,864	AA259040000	BA259040000		40	20,5	106

FV PPR tee

System: **AQUA**
 Material: PP-R
 Standard: ČSN EN ISO 15874

Note: A simple, reliable fitting for branching the pipeline.

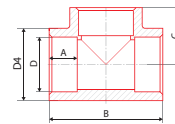

Ø [mm]	⊕	⊞	⊞	⊞	dm ³	# ●	# ●	# ●	D [mm]	D4 [mm]	A [mm]	B [mm]	C [mm]
16	pcs	150	50	0,02	0,08	AA208016000	BA208016000		16	24,6	13,3	44	23,0
20	pcs	160	20	0,03	0,12	AA208020000	BA208020000		20	29,0	14,5	51	25,5
25	pcs	120	20	0,04	0,24	AA208025000	BA208025000		25	36,5	16,0	59	31,4
32	pcs	60	10	0,08	0,40	AA208032000	BA208032000		32	45,3	18,1	71	35,0
40	pcs	48	4	0,13	0,96	AA208040000	BA208040000		40	58,0	20,5	83	41,5
50	pcs	22	2	0,25	1,60	AA208050000	BA208050000		50	74,0	23,5	99	49,0
63	pcs	9	1	0,46	2,74	AA208063000	BA208063000		63	93,0	27,4	120	60,0
75	pcs	6	1	0,62	3,20	AA208075000	BA208075000		75	108,0	31,0	137	68,5
90	pcs	5	1	0,99	4,80	AA208090000	BA208090000		90	128,5	35,5	163	80,5
110	pcs	2	1	1,78	5,50	AA208110000	BA208110000		110	152,6	41,5	186	97,0
125	pcs	1	1	2,51	8,45		BA208125000		125	165,0	40,0	248	124

FV PPR tee reduced

System: **AQUA**
 Material: PP-R
 Standard: ČSN EN ISO 15874

Note: A simple, reliable fitting for branching the pipeline.

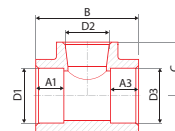

Ø [mm]	⊕	⊞	⊞	⊞	dm ³	# ●	# ●	# ●	D1 [mm]	D2 [mm]	D3 [mm]	B [mm]	C [mm]
20 × 16 × 20	pcs	100	10	0,03	0,10	AA212020016	BA212020016		20	16	20	52,2	27,4
20 × 25 × 20	pcs	100	20	0,03	0,24	AA212020025	BA212020025		20	25	20	64,0	27,0
25 × 20 × 20	pcs	50	10	0,05	0,24	AA212025021	BA212025021		25	20	20	58,8	31,6
25 × 20 × 25	pcs	120	20	0,04	0,24	AA212025020	BA212025020		25	20	25	58,5	31,6
32 × 20 × 32	pcs	90	10	0,07	0,38	AA212032020	BA212032020		32	20	32	61,4	31,5
32 × 25 × 32	pcs	80	10	0,07	0,38	AA212032025	BA212032025		32	25	32	69,1	36,0
40 × 20 × 40	pcs	60	10	0,09	0,46	AA212040020	BA212040020		40	20	40	64,0	38,1
40 × 25 × 40	pcs	50	10	0,13	0,64	AA212040025	BA212040025		40	25	40	73,5	39,6
40 × 32 × 40	pcs	50	10	0,13	0,64	AA212040032	BA212040032		40	32	40	79,3	42,4
50 × 25 × 50	pcs	40	4	0,18	0,96	AA212050025	BA212050025		50	25	50	76,3	49,7
50 × 32 × 50	pcs	30	2	0,19	0,96	AA212050032	BA212050032		50	32	50	82,6	45,9
50 × 40 × 50	pcs	14	2	0,21	0,96	AA212050040	BA212050040		50	40	50	90,3	47,7
63 × 32 × 63	pcs	10	2	0,35	1,92	AA212063032	BA212063032		63	32	63	94,7	52,3
63 × 40 × 63	pcs	10	2	0,34	1,92	AA212063040	BA212063040		63	40	63	98,7	53,9
63 × 50 × 63	pcs	10	2	0,39	1,92	AA212063050	BA212063050		63	50	63	107,3	56,8
90 × 63 × 90	pcs	5	1	0,77	4,80	AA212090063	BA212090063		90	63	90	132,9	73,4
90 × 75 × 90	pcs	5	1	0,85	4,80	AA212090075	BA212090075		90	75	90	142,6	76,4
125 × 75 × 125	pcs	1	1	2,35	7,64		BA212125075		125	75	125	248,0	104,0
125 × 90 × 125	pcs	1	1	2,30	7,72		BA212125090		125	90	125	248,0	106,0
125 × 110 × 125	pcs	1	1	2,38	7,88		BA212125110		125	110	125	248,0	110,0

FV PPR cross piece

System: **AQUA**
 Material: PP-R
 Standard: ČSN EN ISO 15874

Note: A simple, reliable fitting for branching the pipeline.

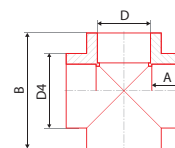

Ø [mm]	⊕	⊞	⊞	⊞	dm ³	# ●	# ●	# ●	D [mm]	D4 [mm]	A [mm]	B [mm]
20	pcs	100	10	0,03	0,16	AA235020000	BA235020000		20	29	14,5	51,0
25	pcs	100	10	0,04	0,24	AA235025000	BA235025000		25	38	16,0	59,2
32	pcs	50	10	0,06	0,32	AA235032000	BA235032000		32	42	18,0	64,0

FV PPR reducing sleeve with plastic male thread

System: **AQUA**
 Material: PP-R
 Standard: ČSN EN ISO 15874
 Note: A fitting for temporary threaded connection.

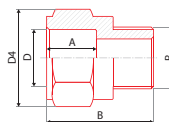

Icon	Symbol	Grid	Grid	Weight	dm³	# ●	# ●	# ●	D [mm]	D4 [mm]	A [mm]	B [mm]	G
	pcs	300	20	0,01	0,03	AA213020012	BA213020012		20	30,8	14,5	34,5	1/2"
	pcs	100	20	0,02	0,04	AA213020034	BA213020034		20	36,4	14,5	44,5	3/4"
	pcs	100	20	0,02	0,05	AA213025034	BA213025034		25	40,5	16,0	45,0	3/4"
	pcs	100	10	0,03	0,10	AA213032001	BA213032001		32	50,0	18,1	55,0	1"
	pcs	60	10	0,07	0,20	AA213040054	BA213040054		40	68,2	20,5	56,8	5/4"
	pcs	40	10	0,12	0,35	AA213050064	BA213050064		50	84,8	23,5	65,0	6/4"
	pcs	20	2	0,22	0,50	AA213063002	BA213063002		63	107,0	27,4	75,0	2"

FV PPR tap elbow for welding internal

System: **AQUA**
 Material: PP-R
 Standard: ČSN EN ISO 15874
 Note: A fitting for temporary threaded connection.

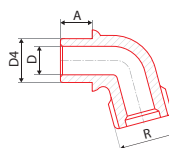

Icon	Symbol	Grid	Grid	Weight	dm³	# ●	# ●	# ●	D [mm]	D4 [mm]	A [mm]	G
	pcs	150	10	0,02	0,08	AA207020034	BA207020034		20	23,0	14,5	3/4"
	pcs	100	10	0,03	0,10	AA207025001	BA207025001		25	28,5	16,0	1"

FV PPR threaded tap connector (fast)

System: **AQUA**
 Material: PP-R
 Standard: ČSN EN ISO 15874
 Note: A connecting fitting for garden irrigation systems.

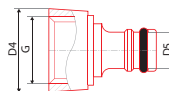

Icon	Symbol	Grid	Grid	Weight	dm³	# ●	# ●	# ●	D4 [mm]	D5 [mm]	G
	pcs	250	50	0,01	0,05	AA256020034	BA256020034		32,7	15,6	3/4"
	pcs	250	50	0,01	0,08	AA256025001	BA256025001		38,6	15,6	1"

FV PPR blinding

System: **AQUA**
 Material: PP-R
 Standard: ČSN EN ISO 15874
 Note: For permanent or temporary blinding of a branch.

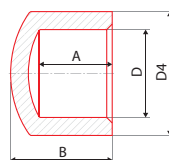

Icon	Symbol	Grid	Grid	Weight	dm³	# ●	# ●	# ●	D [mm]	D4 [mm]	A [mm]	B [mm]
16	pcs	500	50	0,01	0,02	AA229016000	BA229016000		16	23,5	13,3	18,5
20	pcs	300	20	0,01	0,04	AA229020000	BA229020000		20	30,3	14,5	21,0
25	pcs	200	20	0,01	0,05	AA229025000	BA229025000		25	37,0	16,0	25,0
32	pcs	120	10	0,03	0,12	AA229032000	BA229032000		32	46,0	18,1	31,0
40	pcs	60	10	0,05	0,24	AA229040000	BA229040000		40	57,3	20,5	32,5
50	pcs	60	4	0,09	0,30	AA229050000	BA229050000		50	73,5	23,5	41,0
63	pcs	30	2	0,15	0,40	AA229063000	BA229063000		63	89,3	27,4	46,0
75	pcs	10	1	0,26	0,50	AA229075000	BA229075000		75	107,0	30,0	60,0
90	pcs	5	1	0,42	0,60	AA229090000	BA229090000		90	127,0	33,0	69,0
110	pcs	5	1	0,53	0,70	AA229110000	BA229110000		110	151,3	37,0	79,0
125	pcs	1	1	0,77	2,37	AA229125000	BA229125000		125	165,0	40,0	87,0

FV PPR threaded tap connector

System: **AQUA**
 Material: PP-R
 Standard:

Note: A connecting fitting for garden irrigation systems.

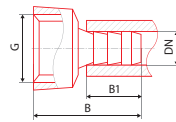

Icon	⊕	⊞	⊞	⊞	⊞	# ●	# ●	# ●	DN* [mm]	B [mm]	B1 [mm]	G
20 x 3/4"	pcs	450	50	0,01	0,05	AA280020034	BA280020034		13	41,1	24,0	3/4"
25 x 1"	pcs	300	25	0,01	0,08	AA280025001	BA280025001		19	46,0	27,4	1"

FV PPR blinding internal

System: **AQUA**
 Material: PP-R
 Standard: ČSN EN ISO 15874

Note: For permanent or temporary blinding of a branch.

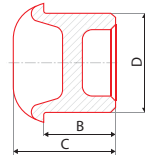

Icon	⊕	⊞	⊞	⊞	⊞	# ●	# ●	# ●	D [mm]	B [mm]	C [mm]
20	pcs	160	40	0,01	0,04	AA245020000	BA245020000		20	23,5	14,5
25	pcs	200	50	0,01	0,06	AA245025000	BA245025000		25	29,0	16,0

FV PPR pressure plug short

System: **AQUA**
 Material: PP-R
 Standard: ČSN EN ISO 15874

Note: For protection against mechanic impurities, non-pressure fitting.

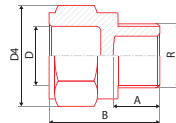

Icon	⊕	⊞	⊞	⊞	⊞	# ●	# ●	# ●	D [mm]	D4 [mm]	A [mm]	B [mm]	G
1/2"	pcs	400	50	0,01	0,04	AA253000000	BA253000000		20	30,8	14,5	34,5	1/2"

FV PP-RCT weld in saddle polyfusion

System: **AQUA**
 Material: PP-R
 Standard: ČSN EN ISO 15874

Note: For additional branches from existing pipeline.
 *Diameter hole is drilled to the desired diameter D1 of branch.

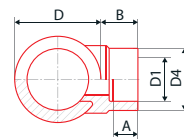

Icon	⊕	⊞	⊞	⊞	⊞	# ●	# ●	# ●	D [mm]	D1 [mm]	D4 [mm]	A [mm]	B [mm]
63 x 32	pcs	120	10	0,036	0,150	AA238063032	BA238063032		63	32	46,0	18	27
75 x 32	pcs	120	10	0,036	0,150	AA238075032	BA238075032		75	32	46,0	18	27
90 x 32	pcs	120	10	0,036	0,150	AA238090032	BA238090032		90	32	46,0	18	27
110 x 32	pcs	120	10	0,036	0,150	AA238110032	BA238110032		110	32	46,0	18	25,7
110 x 40	pcs	1	1	0,048	0,107	AA238110040	BA238110040		110	40	57,2	20,5	27
125 x 20	pcs	1	1	0,025	0,040		BA238125020		125	20	28,3	14,5	29
125 x 25	pcs	1	1	0,022	0,040		BA238125025		125	25	37,5	16	29
125 x 32	pcs	1	1	0,035	0,092		BA238125032		125	32	46,0	18	35
125 x 40	pcs	1	1	0,083	0,150		BA238125040		125	40	57,2	20,5	38
125 x 50	pcs	1	1	0,098	1,189		BA238125050		125	50	67,0	20,5	39
125 x 63	pcs	1	1	0,163	0,312		BA238125063		125	63	93,0	27	45

FV PP washer

System: **AQUA**
Material: PP
Standard:

Note: Washer for mounting fittings in the installation core.

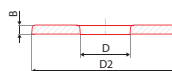

Icon	Icon	Icon	Icon	Icon	Icon	# ●	# ●	# ●	D [mm]	D2 [mm]	B [mm]
66 x 22	pcs	300	1	0,01	0,01	AA251000000	BA251000000		21,3	64,8	4,3

FV PP pressure plug long

System: **AQUA**
Material: PP
Standard: -

Note: Temporary closure of threaded fittings for pressure test.



Icon	Icon	Icon	Icon	Icon	Icon	# ●	# ●	# ●			
1/2"	pcs	120	10	0,02	0,14	AA252000001		blue			
1/2"	pcs	120	10	0,02	0,14		AA252000002	red			

COMBINED FITTINGS

FV PPR elbow 90° with metal male thread

System: **AQUA**
Material: PP-R - brass
Standard: ČSN EN ISO 15874

Note: Transition fitting from plastic part to metal part of pipeline.

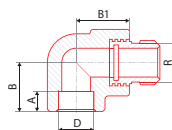

Icon	Icon	Icon	Icon	Icon	Icon	# ●	# ●	# ●	D [mm]	B [mm]	B1 [mm]	A [mm]	R
16 x 1/2"	pcs	120	10	0,07	0,16	AA216016012	BM216016012		16	22	25	13,5	1/2"
20 x 1/2"	pcs	70	10	0,09	0,16	AA216020012	BM216020012		20	27	32	14,5	1/2"
20 x 3/4"	pcs	50	10	0,14	0,32	AA216020034	BM216020034		20	27	35	14,5	3/4"
25 x 1/2"	pcs	60	10	0,13	0,32	AA216025012	BM216025012		25	40	41	16,0	1/2"
25 x 3/4"	pcs	40	10	0,15	0,32	AA216025034	BM216025034		25	40	41	16,0	3/4"
32 x 1"	pcs	40	5	0,22	0,60	AA216032001	BM216032001		32	44	48	18,0	1"

FV PPR reducing sleeve with metal male thread

System: **AQUA**
Material: PP-R - brass
Standard: ČSN EN ISO 15874

Note: Transition fitting from plastic part to metal part of pipeline.



Icon	Icon	Icon	Icon	Icon	Icon	# ●	# ●	# ●	D [mm]	D4 [mm]	D5 [mm]	A [mm]	R
16 x 1/2"	pcs	100	10	0,09	0,10	AA215016012	BM215016012		16	24,6	35,5	13,0	1/2"
20 x 1/2"	pcs	100	10	0,08	0,10	AA215020012	BM215020012		20	29,1	35,0	14,5	1/2"
20 x 3/4"	pcs	70	10	0,14	0,16	AA215020034	BM215020034		20	29,1	41,0	14,5	3/4"
25 x 1/2"	pcs	80	10	0,10	0,15	AA215025012	BM215025012		25	35,5	35,2	16,0	1/2"
25 x 3/4"	pcs	60	10	0,14	0,16	AA215025034	BM215025034		25	36,2	42,4	16,0	3/4"
32 x 1"	pcs	80	10	0,19	0,27	AA215032001	BM215032001		32	46,3	50,6	18,0	1"
40 x 5/4"	pcs	40	4	0,31	0,46	AA215040054	BM215040054		40	59,2	66,8	20,5	5/4"
50 x 6/4"	pcs	20	4	0,34	0,69	AA215050064	BM215050064		50	74,5	67,4	23,5	6/4"
63 x 2"	pcs	12	1	0,73	1,37	AA215063002	BM215063002		63	93,5	84,5	27,0	2"
75 x 2,5"	pcs	9	1	1,11	2,74	AA215075025	BM215075025		75	110,0	106,0	30,0	2,5"
90 x 3"	pcs	6	1	1,64	3,20	AA215090003	BM215090003		90	133,2	125,0	33,0	3"
125 x 5"	pcs	1	1	4,38	4,05		BM215125005		125	138,0	208,0	40,0	5"

FV PPR reducing sleeve with metal female thread

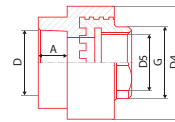

System: **AQUA**
 Material: PP-R - brass
 Standard: ČSN EN ISO 15874
 Note: Transition fitting from plastic part to metal part of pipeline.

Objekt	Symbol	Skupina	Podskupina	Objem	hm ³	# ●	# ●	# ●	D [mm]	D4 [mm]	D5 [mm]	A [mm]	G
16 x 1/2"	pcs	100	10	0,06	0,10	AA217016012	BM217016012		16	39,2	32,2	13,3	1/2"
20 x 1/2"	pcs	100	10	0,06	0,10	AA217020012	BM217020012		20	40,0	30,0	14,5	1/2"
20 x 3/4"	pcs	70	10	0,11	0,16	AA217020034	BM217020034		20	45,5	29,3	14,5	3/4"
25 x 1/2"	pcs	100	10	0,06	0,16	AA217025012	BM217025012		25	39,5	36,0	16,0	1/2"
25 x 3/4"	pcs	40	10	0,10	0,16	AA217025034	BM217025034		25	45,4	36,0	16,0	3/4"
32 x 1"	pcs	60	10	0,18	0,27	AA217032001	BM217032001		32	57,5	46,5	18,1	1"
40 x 5/4"	pcs	40	5	0,275	0,45	AA217040054	BM217040054		40	76,8	60,3	20,5	5/4"
50 x 6/4"	pcs	28	2	0,343	0,64	AA217050064	BM217050064		50	82,7	74,3	23,5	6/4"
63 x 2"	pcs	15	1	0,520	1,20	AA217063002	BM217063002		63	107,0	94,0	27,4	2"
125 x 5"	pcs	1	1				BM217125005		125	206,0	168,0	40,0	5"

FV PPR elbow 90° with metal female thread

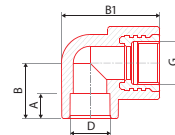

System: **AQUA**
 Material: PP-R - brass
 Standard: ČSN EN ISO 15874
 Note: Transition fitting from plastic part to metal part of pipeline.

Objekt	Symbol	Skupina	Podskupina	Objem	hm ³	# ●	# ●	# ●	D [mm]	B [mm]	B1 [mm]	A [mm]	G
16 x 1/2"	pcs	150	10	0,07	0,16	AA218016012	BM218016012		16	22,0	25,0	13,5	1/2"
20 x 1/2"	pcs	80	10	0,06	0,16	AA218020012	BM218020012		20	27,0	32,0	14,5	1/2"
20 x 3/4"	pcs	50	10	0,13	0,32	AA218020034	BM218020034		20	40,0	41,0	14,5	3/4"
25 x 1/2"	pcs	60	10	0,10	0,32	AA218025012	BM218025012		25	40,0	41,0	16,0	1/2"
25 x 3/4"	pcs	50	10	0,12	0,32	AA218025034	BM218025034		25	40,0	41,0	16,0	3/4"
32 x 1"	pcs	40	5	0,20	0,60	AA218032001	BM218032001		32	44,0	48,0	18,0	1"

FV PPR weld in saddle with metal male thread

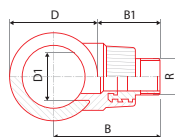

System: **AQUA**
 Material: PP-R - brass
 Standard: ČSN EN ISO 15874
 Note: Transition fitting from plastic part to metal part of pipeline, for additional branches.

Objekt	Symbol	Skupina	Podskupina	Objem	hm ³	# ●	# ●	# ●	D [mm]	D1 [mm]	B [mm]	B1 [mm]	R
63 x 3/4"	pcs	120	10	0,112	0,170	AA248063032	BM248063032		63	32	76,3	44,8	3/4"
75 x 3/4"	pcs	120	10	0,117	0,170	AA248075032	BM248075032		75	32	82,3	44,8	3/4"
90 x 3/4"	pcs	120	10	0,112	0,170	AA248090032	BM248090032		90	32	89,8	44,8	3/4"
125 x 25 x 1/2"	pcs	1	1	0,090	0,048		BM248125025		63-125	25	73,5-104,5	42	1/2"
125 x 25 x 3/4"	pcs	1	1	0,132	0,056		BM248125026		63-125	25	80,5-111,5	49	3/4"
125 x 32 x 3/4"	pcs	1	1	0,116	0,100		BM248125032		63-125	32	80,5-111,5	49	3/4"
125 x 40 x 1"	pcs	1	1	0,234	0,168		BM248125040		75-125	40	91,5-116,5	54	1"
125 x 50 x 5/4"	pcs	1	1	0,342	0,227		BM248125050		90-125	50	104-121,5	59	1 1/4"
125 x 50 x 6/4"	pcs	1	1	0,350	0,227		BM248125051		90-125	50	104-121,5	59	1 1/2"
125 x 63 x 2"	pcs	1	1	0,632	0,227		BM248125063		110-125	63	95-102,5	40	2"

FV PPR weld in saddle with metal female thread

System: **AQUA**

Material: PP-R - brass

Standard: ČSN EN ISO 15874

Note: Transition fitting from plastic part to metal part of pipeline, for additional branches.

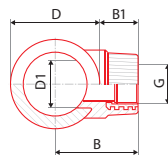

Objekt	Symbol	Skupina	Podskupina	hm	dm ³	# ●	# ●	# ●	D [mm]	D1 [mm]	B [mm]	B1 [mm]	G
63 × 3/4"	pcs	120	10	0,091	0,17	AA247063032	BM247063032		63	32	58,5	27,00	3/4"
75 × 3/4"	pcs	120	10	0,091	0,17	AA247075032	BM247075032		75	32	64,5	27,00	3/4"
90 × 3/4"	pcs	120	10	0,090	0,17	AA247090032	BM247090032		90	32	72,0	27,00	3/4"
125 × 25 × 1/2"	pcs	1	1	0,058	0,03		BM247125025		63-125	25	60,5-91,5	29	1/2"
125 × 32 × 3/4"	pcs	1	1	0,102	0,07		BM247125032		63-125	32	66,5-97,5	35	3/4"
125 × 40 × 1"	pcs	1	1	0,194	0,12		BM247125040		75-125	40	75,5-100,5	38	1"
125 × 40 × 5/4"	pcs	1	1	0,194	0,12		BM247125041		75-125	40	75,5-100,5	38	1 1/4"
125 × 50 × 5/4"	pcs	1	1	0,240	0,15		BM247125050		90-125	50	84-101,5	39	1 1/4"
125 × 50 × 6/4"	pcs	1	1	0,244	0,15		BM247125051		90-125	50	84-101,5	39	1 1/2"
125 × 63 × 2"	pcs	1	1	0,490	0,26		BM247125063		110-125	63	100-107,5	45	2"

FV PPR reducing sleeve with metal female thread with cross

System: **AQUA**

Material: PP-R - brass

Standard: ČSN EN ISO 15874

Note: Transition fitting from plastic part to metal part of pipeline.

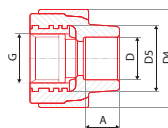

Objekt	Symbol	Skupina	Podskupina	hm	dm ³	# ●	# ●	# ●	D [mm]	D4 [mm]	D5 [mm]	A [mm]	G
20 × 1/2"	pcs	100	10	0,06	0,11	AA217022012	BM217022012		20	38	28,1	14,5	1/2"

FV PPR tee with metal female thread

System: **AQUA**

Material: PP-R - brass

Standard: ČSN EN ISO 15874, DIN 8077, DIN 8078

Note: Transition fitting from plastic part to metal part of pipeline.

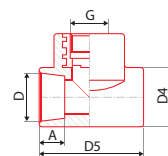

Objekt	Symbol	Skupina	Podskupina	hm	dm ³	# ●	# ●	# ●	D [mm]	D4 [mm]	D5 [mm]	A [mm]	G
20 × 1/2"	pcs	60	10	0,07	0,19	AA222020012	BM222020012		20	29,0	37,0	14,5	1/2"
25 × 1/2"	pcs	40	10	0,08	0,24	AA222025012	BM222025012		25	36,0	37,0	16,0	1/2"
25 × 3/4"	pcs	30	10	0,13	0,32	AA222025034	BM222025034		25	38,4	46,5	16,0	3/4"
32 × 1"	pcs	40	5	0,22	0,60	AA222032001	BM222032001		32	48,4	58,0	18,1	1"

FV PPR tee with metal male thread

System: **AQUA**

Material: PP-R - brass

Standard: ČSN EN ISO 15874

Note: Transition fitting from plastic part to metal part of pipeline.

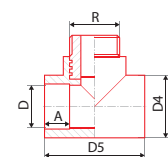

Objekt	Symbol	Skupina	Podskupina	hm	dm ³	# ●	# ●	# ●	D [mm]	D4 [mm]	D5 [mm]	A [mm]	R
20 × 1/2"	pcs	100	10	0,09	0,19	AA254020012	BM254020012		20	29,2	36,8	14,5	1/2"
25 × 1/2"	pcs	40	10	0,10	0,24	AA254025012	BM254025012		25	37,0	41,0	16,0	1/2"
25 × 3/4"	pcs	30	10	0,17	0,32	AA254025034	BM254025034		32	37,0	41,0	16,0	3/4"

FV PPR metal reducer with cap nut

System: **AQUA**
 Material: PP-R - brass
 Standard: ČSN EN ISO 15874, DIN 8077, DIN 8078
 Note: Transition fitting from plastic part to metal part of pipeline.

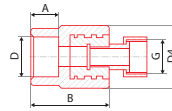

										D [mm]	D4 [mm]	A [mm]	B [mm]	G
16 x 1/2"	pcs	120	10	0,05	0,05	AA223016012	BM223016012			16	37	13,3	33,6	1/2"
16 x 3/4"	pcs	100	10	0,08	0,06	AA223016034	BM223016034			16	37	13,3	37,0	3/4"
20 x 1/2"	pcs	120	10	0,05	0,05	AA223020012	BM223020012			20	37	14,5	33,6	1/2"
20 x 3/4"	pcs	100	10	0,08	0,06	AA223020034	BM223020034			20	37	14,5	37,0	3/4"
20 x 1"	pcs	50	10	0,23	0,06	AA223020001	BM223020001			20	43	14,5	43,0	1"
25 x 3/4"	pcs	100	10	0,26	0,06	AA223025034	BM223025034			25	37	16,0	39,0	3/4"
25 x 1"	pcs	40	10	0,26	0,07	AA223025001	BM223025001			25	43	16,0	44,0	1"
32 x 5/4"	pcs	25	5	0,38	0,12	AA223032054	BM223032054			32	52	18,1	47,5	5/4"

FV PPR union plastic / brass unwelded

System: **AQUA**
 Material: PP-R - brass
 Standard: ČSN EN ISO 15874, DIN 8077, DIN 8078
 Note: Transition fitting from plastic part to metal part of pipeline. | * with a hole for seal

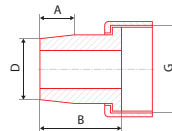

										D [mm]	A [mm]	B [mm]	G
20 x 3/4"	pcs	150	50	0,04	0,05	AA225020034	BM225020034			20	14,5	35,5	3/4"
25 x 1"	pcs	80	20	0,07	0,10	AA225025001	BM225025001			25	16,0	45,2	1"
32 x 5/4"	pcs	45	15	0,10	0,18	AA225032054	BM225032054			32	18,0	45,3	5/4"
40 x 6/4"	pcs	40	1	0,16	0,22	AA225040064	BM225040064			40	20,5	51,5	6/4"
50 x 2"	pcs	20	1	0,30	0,41	AA225050002	BM225050002			50	23,5	60,5	2"
* 20 x 3/4"	pcs	150	50	0,04	0,05	AA225020134	BM225020134			20	14,8	35,5	3/4"

FV PPR plastic reducing sleeve with cap nut

System: **AQUA**
 Material: PP-R - brass
 Standard: ČSN EN ISO 15874, DIN 8077, DIN 8078
 Note: Transition fitting from plastic part to metal part of pipeline | * with a hole for seal

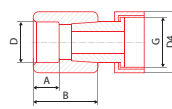

										D [mm]	D4 [mm]	A [mm]	B [mm]	G
16 x 3/4"	pcs	220	20	0,05	0,16	AA226016034	BM226016034			16	29,2	13,0	33,1	3/4"
20 x 1/2"	pcs	300	25	0,04	0,16	AA226020012	BM226020012			20	29,2	14,5	34,0	1/2"
20 x 3/4"	pcs	200	20	0,05	0,16	AA226020034	BM226020034			20	28,6	14,5	32,4	3/4"
25 x 3/4"	pcs	150	10	0,05	0,19	AA226025034	BM226025034			25	36,8	16,0	34,4	3/4"
25 x 1"	pcs	120	10	0,09	0,19	AA226025001	BM226025001			25	36,7	16,0	35,0	1"
32 x 1"	pcs	100	10	0,10	0,48	AA226032001	BM226032001			32	47,0	18,0	38,0	1"
* 20 x 3/4"	pcs	200	20	0,05	0,16	AA226020134	BM226020134			20	28,6	14,5	32,0	3/4"
* 25 x 3/4"	pcs	150	10	0,05	0,19	AA226025134	BM226025134			25	36,8	16,0	34,0	3/4"

FV PPR coupling with nut

System: **AQUA**
 Material: PP-R - brass
 Standard: ČSN EN ISO 15874, DIN 8077, DIN 8078
 Note: Mountable and demountable joint

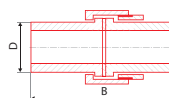

Ø	⊕	⊞	⊠	⊡	dm ³	# ●	# ●	# ●	D [mm]	B [mm]
20	pcs	200	10	0,08	0,15	AA224020000	BM224020000		20	73,0
25	pcs	120	5	0,12	0,20	AA224025000	BM224025000		25	93,5
32	pcs	70	5	0,19	0,25	AA224032000	BM224032000		32	93,5
40	pcs	50	5	0,27	0,35	AA224040000	BM224040000		40	105,0
50	pcs	25	5	0,49	0,65	AA224050000	BM224050000		50	123,0

FV PPR elbow 90° plastic reducing sleeve with cap nut

System: **AQUA**
 Material: PP-R - brass
 Standard: ČSN EN ISO 15874
 Note: Transition fitting from plastic part to metal part of pipeline, * with a hole for seal

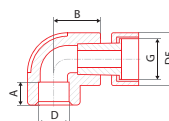

Ø	⊕	⊞	⊠	⊡	dm ³	# ●	# ●	# ●	D [mm]	D4 [mm]	A [mm]	B [mm]	G
20 × 1/2"	pcs	250	25	0,04	0,02	AA227020012	BM227020012		20	29,0	14,5	29,3	1/2"
20 × 3/4"	pcs	180	20	0,06	0,03	AA227020034	BM227020034		25	30,0	14,5	25,5	3/4"
25 × 3/4"	pcs	120	10	0,06	0,10	AA227025034	BM227025034		32	36,6	16,0	32,0	3/4"
* 20 × 3/4"	pcs	180	20	0,06	0,02	AA227020134	BM227020134		20	30,0	14,5	25,5	3/4"

FV PPR tee plastic reducing sleeve with cap nut

System: **AQUA**
 Material: PP-R - brass
 Standard: ČSN EN ISO 15874
 Note: Transition fitting from plastic part to metal part of pipeline | * with a hole for seal

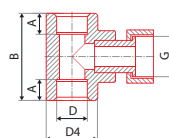

Ø	⊕	⊞	⊠	⊡	dm ³	# ●	# ●	# ●	D [mm]	D4 [mm]	A [mm]	B [mm]	G
20 × 3/4" × 20	pcs	130	10	0,07	0,24	AA228020034	BM228020034		20	29,0	14,5	51,0	3/4"
25 × 3/4" × 25	pcs	80	10	0,08	0,32	AA228025034	BM228025034		25	36,6	16,0	58,0	3/4"
32 × 3/4" × 32	pcs	60	10	0,11	0,38	AA228032034	BM228032034		32	46,0	18,1	61,4	3/4"
32 × 1" × 32	pcs	50	10	0,13	0,38	AA228032044	BM228032044		32	45,6	18,1	69,0	1"
* 20 × 3/4" × 20	pcs	120	20	0,07	0,24	AA228020134	BM228020134		20	29,0	14,5	51,0	3/4"
* 25 × 3/4" × 25	pcs	80	10	0,08	0,32	AA228025134	BM228025134		25	36,6	16,0	58,0	3/4"

FV PPR flange adaptor

System: **AQUA**
 Material: PP-R
 Standard: ČSN EN ISO 15874
 Note: Plastic fitting for flange dismountable joints.

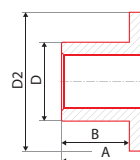

Ø	⊕	⊞	⊠	⊡	dm ³	# ●	# ●	# ●	D [mm]	DN [mm]	D2 [mm]	A [mm]	B [mm]
40/32	pcs	40	4	0,07	0,35	AA230040032	BA230040032		40	32	78	50	38,0
50/40	pcs	40	2	0,10	0,55	AA230050040	BA230050040		50	40	98	55	43,0
63/50	pcs	20	2	0,15	0,67	AA230063050	BA230063050		60	50	112	60	46,5
75/65	pcs	15	1	0,26	1,20	AA230075065	BA230075065		75	65	122	66	50,0
90/80	pcs	10	1	0,37	1,35	AA230090080	BA230090080		90	80	135	82	63,0
110/100	pcs	5	1	0,62	2,45	AA230110100	BA230110100		110	100	163	100	82,0
125/100	pcs	1	1	0,36	2,34	AA230125100	BA230125100		125	100	162	53	40,0
125/125	pcs	1	1	1,34	5,38	AA230125125	BA230125125		125	125	188	185	145

FV PPR FE flange

System: **AQUA**
 Material: steel
 Standard:

Note: Metal fitting for flange dismountable joints.

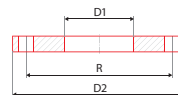

Objekt	Symbol	Objekt	Objekt	Objekt	Objekt	# ●	# ●	# ●	D1 [mm]	D2 [mm]	R [mm]	d	number of holes
40/32	pcs	1	1	1,42	0,35	AA231040032			43	140	100	M 16	4
50/40	pcs	1	1	1,82	0,38	AA231050040			53	150	110	M 16	4
63/50	pcs	1	1	2,23	0,45	AA231063050			66	165	125	M 16	4
75/65	pcs	1	1	2,48	0,55	AA231075065			78	185	145	M 16	4
90/80	pcs	1	1	3,25	0,80	AA231090080			95	200	160	M 16	8
110/100	pcs	1	1	3,60	0,97	AA231110100			114	220	180	M 16	8
125/100	pcs	1	1	1,078	0,68	AA231125100			149	220	180	M 16	8
125/125	pcs	1	1	1,844	1,18	AA231125125			158	250	210	M 16	8

FV PPR transition union male

System: **AQUA**
 Material: PP-R - brass
 Standard: ČSN EN ISO 15874

Note: Transition demountable fitting from plastic part to metal part of pipeline.

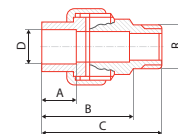

Objekt	Symbol	Objekt	Objekt	Objekt	Objekt	# ●	# ●	# ●	D [mm]	A [mm]	B [mm]	C [mm]	R
20 x 1/2"	pcs	125	1	0,11	0,09	AA237020012	BM237020012		20	14,5	41	53	1/2"
25 x 3/4"	pcs	65	1	0,19	0,17	AA237025034	BM237025034		25	16,0	44	59	3/4"
32 x 1"	pcs	50	1	0,25	0,22	AA237032001	BM237032001		32	18,1	46	63	1"
40 x 5/4"	pcs	25	1	0,36	0,44	AA237040054	BM237040054		40	20,5	51	68	5/4"
50 x 6/4"	pcs	20	1	0,59	0,55	AA237050064	BM237050064		50	23,5	52	70	6/4"
63 x 2"	pcs	8	1	1,03	1,37	AA237063002	BM237063002		63	27,4	64	90	2"

FV PPR transition union female

System: **AQUA**
 Material: PP-R - brass
 Standard: ČSN EN ISO 15874

Note: Transition demountable fitting from plastic part to metal part of pipeline.

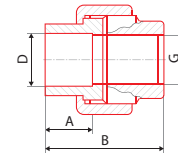

Objekt	Symbol	Objekt	Objekt	Objekt	Objekt	# ●	# ●	# ●	D [mm]	A [mm]	B [mm]	G
20 x 1/2"	pcs	150	1	0,10	0,07	AA236020012	BM236020012		20	14,5	41	1/2"
25 x 3/4"	pcs	75	1	0,16	0,15	AA236025034	BM236025034		25	16,0	44	3/4"
32 x 1"	pcs	50	1	0,19	0,22	AA236032001	BM236032001		32	18,0	46	1"
32 x 5/4"	pcs	50	1	0,29	0,36	AA236032054	BM236032054		32	18,0	51	5/4"
40 x 5/4"	pcs	30	1	0,32	0,36	AA236040054	BM236040054		40	20,5	51	5/4"
50 x 6/4"	pcs	25	1	0,48	0,55	AA236050064	BM236050064		50	23,5	52	6/4"
63 x 2"	pcs	8	1	0,82	1,37	AA236063002	BM236063002		63	27,4	64	2"

FV PPR transition union male with nipple

System: **AQUA**
 Material: PP-R - brass
 Standard: ČSN EN 15874, DIN 8077, DIN 8078

Note:

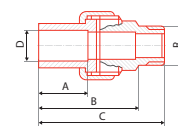

Objekt	Symbol	Objekt	Objekt	Objekt	Objekt	# ●	# ●	# ●	D [mm]	A [mm]	B [mm]	C [mm]	R
20 x 1/2"	pcs	125	1	0,11	0,09	AA263020012	BM263020012		20	30,5	57	69	1/2"
25 x 3/4"	pcs	65	1	0,19	0,17	AA263025034	BM263025034		25	32,0	60	75	3/4"
32 x 1"	pcs	50	5	0,25	0,22	AA263032001	BM263032001		32	34,0	62	79	1"
40 x 5/4"	pcs	25	1	0,36	0,44	AA263040054	BM263040054		40	36,5	67	84	5/4"
50 x 6/4"	pcs	20	1	0,59	0,55	AA263050064	BM263050064		50	39,5	68	86	6/4"
63 x 2"	pcs	8	1	1,03	1,37	AA263063002	BM263063002		63	43,4	80	106	2"

FV PPR transition union female with nipple

System: **AQUA**
 Material: PP-R - brass
 Standard: ČSN EN 15874, DIN 8077, DIN 8078

Note:

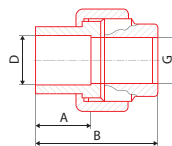

Icon	Icon	Icon	Icon	Icon	Icon	# ●	# ●	# ●	D [mm]	A [mm]	B [mm]	G
						AA262020012	BM262020012		20	14,5	41	1/2"
						AA262025034	BM262025034		25	16,0	44	3/4"
						AA262032001	BM262032001		32	18,0	46	1"
						AA262032054	BM262032054		32	18	51	5/4"
						AA262040054	BM262040054		40	20,5	51	5/4"
						AA262050064	BM262050064		50	23,5	52	6/4"
						AA262063002	BM262063002		63	27,4	64	2"

FV PPR elbow 90° for wall mounting

System: **AQUA**
 Material: PP-R - brass
 Standard: ČSN EN ISO 15874

Note: Fixing fitting with tap connector for mixers.

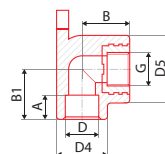

Icon	Icon	Icon	Icon	Icon	Icon	# ●	# ●	# ●	D [mm]	D5 [mm]	D4 [mm]	B [mm]	G
						AA219016012	BM219016012		16	38,6	28,2	35,0	1/2"
						AA219020012	BM219020012		20	39,6	30,2	34,3	1/2"
						AA219025012	BM219025012		25	46,4	37,2	40,0	1/2"
						AA219025034	BM219025034		25	46,4	37,2	40,0	3/4"

FV PPR elbow 90° for wall mounting internal / external

System: **AQUA**
 Material: PP-R - brass
 Standard: ČSN EN ISO 15874

Note: A simple, reliable fitting for changing the pipeline direction.

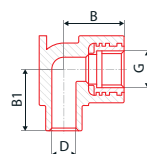

Icon	Icon	Icon	Icon	Icon	Icon	# ●	# ●	# ●	D [mm]	B [mm]	B1 [mm]	C [mm]	G
						AA239020012	BM239020012		20	35	35	11	1/2"

FV PPR elbow 90° for wall mounting left and right

System: **AQUA**
 Material: PP-R - brass
 Standard: ČSN EN ISO 15874

Note: Fixing fitting with tap connector for mixers.

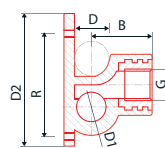

Icon	Icon	Icon	Icon	Icon	Icon	# ●	# ●	# ●	D [mm]	B [mm]	R [mm]	D2 [mm]	G
						AA219020013			20	34	62,1	74	1/2"
						AA219020014			20	34	62,1	74	1/2"

FV PPR elbow with metal female thread UNI

System: **AQUA**
 Material: PP-R - brass
 Standard: ČSN EN ISO 15874

Note: Fixing fitting with tap connector for mixers.

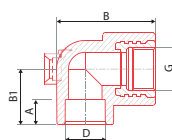

Icon	Icon	Icon	Icon	Icon	Icon	# ●	# ●	# ●	D [mm]	B [mm]	B1 [mm]	A [mm]	G
						AA258020012	BM258020012		20	54	27	14,5	1/2"

FV PPR holder MONO for UNI elbow

System: **AQUA**
 Material: PP-R
 Standard:

Note: Fixing fitting with tap connector for mixers.

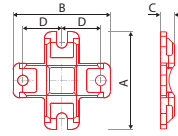

Icon	Symbol	Quantity	Weight	Volume	Material	Product Code	Accessories	Material	D [mm]	B [mm]	A [mm]	C [mm]
20 x 1/2"	pcs	200	10	0,008	0,036	AA258800000			24	60	60	8,9

FV PPR holder DUO for UNI elbow

System: **AQUA**
 Material: PP-R
 Standard:

Note: Transition fitting from plastic part to metal part of pipeline.

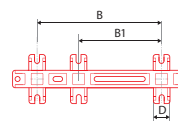

Icon	Symbol	Quantity	Weight	Volume	Material	Product Code	Accessories	Material	D [mm]	B [mm]	B1 [mm]
20 x 1/2"	pcs	120	10	0,029	0,180	AA258900000			20	150	100

FV PPR wall elbows with holder

System: **AQUA**
 Material: PP-R - brass
 Standard: ČSN EN ISO 15874

Note: Tap water connectors with adjustable distance of 100 or 150 mm.

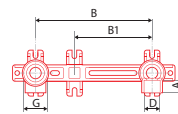

Icon	Symbol	Quantity	Weight	Volume	Material	Product Code	Accessories	Material	D [mm]	A [mm]	B [mm]	B1 [mm]	G
20 x 1/2"	pcs	30	5	0,163	0,60	AA255020012	BM255020012		20	15	150	100	1/2"

FV PPR elbow for gypsum wall mounting

System: **AQUA**
 Material: PP-R - brass
 Standard: ČSN EN ISO 15874

Note: Fixing fitting with tap connector for mixers, for gypsum walls.

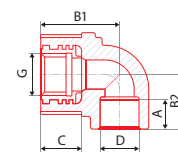

Icon	Symbol	Quantity	Weight	Volume	Material	Product Code	Accessories	Material	D [mm]	A [mm]	B1,B2 [mm]	C [mm]	G
20 x 1/2"	pcs	50	1	0,13	1,02	AA240020012	BM240020012		20	15	42,27	25	1/2"

FV PPR tee with tap connector

System: **AQUA**
 Material: PP-R - brass
 Standard: ČSN EN ISO 15874

Note: Fixing fitting with tap connector for mixers.

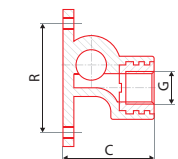

Icon	Symbol	Quantity	Weight	Volume	Material	Product Code	Accessories	Material	D [mm]	A [mm]	B [mm]	B1 [mm]	G
20 x 1/2"	pcs	60	10	0,08	0,21	AA220020012	BM220020012		20	14,5	50	61,5	1/2"
25 x 1/2"	pcs	50	10	0,09	0,36	AA220025012	BM220025012		25	16,0	56	75,0	1/2"

FV PPR wall mounting group with tap connectors

System: **AQUA**
 Material: PP-R - brass
 Standard: -

Note: Tap water connectors with adjustable distance of 100 or 150 mm. Set pitch 105/130/145 and 110/125/140 mm, need to be balance with an eccentric tray.

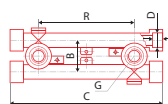

Icon	⊕	⊞	⊞	⊞	⊞	# ●	# ●	# ●	D [mm]	A [mm]	B [mm]	C [mm]	G
2 × 20 × 1/2"	pcs	15	1	0,20	1,37	AA221020012	BM221020012		20	14,5	46	222	1/2"
2 × 25 × 1/2"	pcs	10	1	0,31	1,32	AA221025012	BM221025012		25	16,0	51	230	1/2"

FV PPR wall elbow with holder

System: **AQUA**
 Material: PP-R - brass
 Standard: ČSN EN 15874, DIN 8077, DIN 8078

Note: Tap water connectors with tough distance of 150 mm.

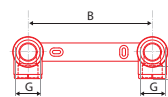

Icon	⊕	⊞	⊞	⊞	⊞	# ●	# ●	# ●	A [mm]	B [mm]	G
20 × 1/2"	pcs	36	1	0,165	0,518	AA249020012	BM249020012		14,5	150	1/2"
25 × 1/2"	pcs	36	1	0,179	0,518	AA249025012	BM249025012		16,0	150	1/2"

FV PPR assembling plate for elbow 90° for wall mounting

System: **AQUA**
 Material: PP-R
 Standard: -

Note: A practical accessory for an easy installation into dry building systems.

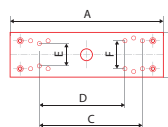

Icon	⊕	⊞	⊞	⊞	⊞	# ●	# ●	# ●	A [mm]	B [mm]	C [mm]	D [mm]	E, F [mm]
	pcs	60	1	0,08	0,15	AA251000001			220	64	135	110	40,45

FV PPR electro-fusion socket

System: **AQUA**
 Material: PP-R
 Standard: -

Note: A fitting for pipe connection under electro-fusion welding condition.

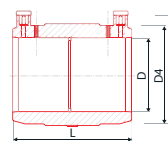

Icon	⊕	⊞	⊞	⊞	⊞	# ●	# ●	# ●	D [mm]	D4 [mm]	L [mm]	H [mm]
20	pcs	1	1			AA234020000			20			
25	pcs	1	1	0.066	0.020	AA234025000			25	40	40	53
32	pcs	1	1	0.086	0.038	AA234032000			32	47	47	60
40	pcs	1	1	0.114	0.070	AA234040000			40	56	56	69
50	pcs	1	1	0.192	0.137	AA234050000			50	70	70	83
63	pcs	1	1	0.278	0.262	AA234063000			63	84	84	97
75	pcs	1	1	0.450	0.442	AA234075000			75	100	100	113
90	pcs	1	1	0.652	0.763	AA234090000			90	120	120	133
110	pcs	1	1			AA234110000			110	146	146	159
125	pcs	1	1	0.950	3.960		BA234125000		125	156	151	168

FV PPR joining elbow 45° to the radiator

System: **AQUA**
 Material: PP-R - brass
 Standard: ČSN EN ISO 15877
 Note: For radiator connection.

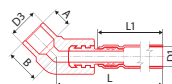

Icon	⊕	⊞	⊞	⊞	dm³	# ●	# ●	# ●	A [mm]	B [mm]	D1, D3 [mm]	L [mm]	L1 [mm]
	20	pcs	20	1	0,126	AA244020270			14,5	24	15, 20	300	270
	20	pcs	10	1	0,273	AA244020720			14,5	24	15, 20	750	720

FV PPR joining elbow 90° to the radiator

System: **AQUA**
 Material: PP-R - brass
 Standard: ČSN EN ISO 15874
 Note: For radiator connection.

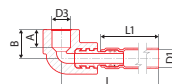

Icon	⊕	⊞	⊞	⊞	dm³	# ●	# ●	# ●	A [mm]	B [mm]	D1, D3 [mm]	L [mm]	L1 [mm]
	20	pcs	20	1	0,123	AA243020270			13	22,5	15, 20	298	270
	20	pcs	10	1	0,270	AA243020720			13	22,5	15, 20	748	720

FV PPR sleeve euroconus with metal thread

System: **AQUA**
 Material: PP-R - brass
 Standard: ČSN EN ISO 15874
 Note: Transition fitting for radiator connection.

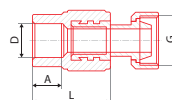

Icon	⊕	⊞	⊞	⊞	dm³	# ●	# ●	# ●	D [mm]	A [mm]	G	L [mm]
	20 x 3/4"	pcs	100	10	0,091	0,154	AA257020034		20	14,5	3/4"	40

SHUT-OFF VALVES

FV PPR ball valve plastic with a butterfly / FV PPR ball valve plastic with a lever

System: **AQUA**
 Material: PP-R - brass
 Standard: ČSN EN ISO 15874
 Note: A ball valve with a chromed ball and teflon seals.

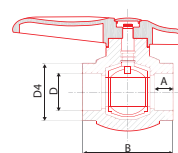

Icon	⊕	⊞	⊞	⊞	dm³	# ●	# ●	# ●		D [mm]	D4 [mm]	A [mm]	B [mm]
	16	pcs	40	10	0,12	0,17	AA271016000	BA271016000	s motýlkem	16	22,8	13,0	58,6
	20	pcs	40	10	0,12	0,34	AA271020000	BA271020000	s motýlkem	20	31,2	14,5	61,1
	20	pcs	40	10	0,12	0,34	AA271020100	BA271020100	s páčkou	20	31,2	14,5	61,1
	25	pcs	40	4	0,21	0,69	AA271025000	BA271025000	s páčkou	25	37,4	16,0	74,5
	32	pcs	20	2	0,36	0,69	AA271032000	BA271032000	s páčkou	32	48,5	18,0	85,0
	40	pcs	15	1	0,36	1,60	AA271040000	BA271040000	s páčkou	40	60,4	20,5	98,0
	50	pcs	9	1	0,65	1,60	AA271050000	BA271050000	s páčkou	50	75,0	23,5	116,3
	63	pcs	6	1	1,12	4,80	AA271063000	BA271063000	s páčkou	63	92,5	27,5	131,0
	75	pcs	4	1	1,83	4,80	AA271075000	BA271075000	s páčkou	75	108,0	30,0	165,0

FV PPR radiator ball valve straight

System: **AQUA**
 Material: PP-R - brass
 Standard: ČSN EN ISO 15874

Note: A ball valve with a chromed ball and teflon seals.

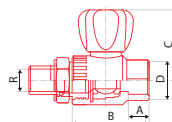

Icon	⊕	⊞	⊞	⊞	dm³	# ●	# ●	# ●	D [mm]	D4 [mm]	A [mm]	B [mm]	C [mm]
20 x 1/2"	pcs	60	1	0,154	0,12	AA289020012			20	29	16,1	55,1	52
25 x 3/4"	pcs	40	1	0,198	0,16	AA289025034			25	36,5	17,1	60,2	56

FV PPR radiator ball valve elbow

System: **AQUA**
 Material: PP-R - brass
 Standard: ČSN EN ISO 15874

Note: A ball valve with a chromed ball and teflon seals.

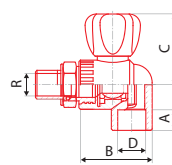

Icon	⊕	⊞	⊞	⊞	dm³	# ●	# ●	# ●	D [mm]	D4 [mm]	A [mm]	B [mm]	C [mm]
20 x 1/2"	pcs	50	1	0,160	0,13	AA290020012			20	29	15,1	51	52
25 x 3/4"	pcs	40	1	0,198	0,18	AA290025034			25	36,5	17,1	60,5	56

FV PPR ball valve plastic with PV valve

System: **AQUA**
 Material: PP-R - brass
 Standard: ČSN EN ISO 15874

Note: A ball valve with a chromed ball and teflon seals.

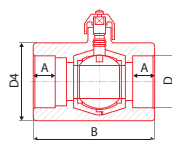

Icon	⊕	⊞	⊞	⊞	dm³	# ●	# ●	# ●	D [mm]	D4 [mm]	A [mm]	B [mm]
20	pcs	60	10	0,14	0,37	AA272020000	BA272020000		20	31,4	14,5	74,5
25	pcs	60	10	0,14	0,40	AA272025000	BA272025000		25	38,2	16,0	78,5
32	pcs	30	2	0,24	0,80	AA272032000	BA272032000		32	49,0	18,0	91,0
40	pcs	20	2	0,38	1,60	AA272040000	BA272040000		40	60,0	20,5	105,0
50	pcs	14	1	0,66	1,60	AA272050000	BA272050000		50	76,0	23,5	121,5
63	pcs	8	1	1,14	4,80	AA272063000	BA272063000		63	94,0	27,5	144,0
75	pcs	5	1	1,85	4,80	AA272075000	BA272075000		75	108,0	30,0	165,0

* The hexagonal valve at the valve body is a structural element that serves to fix and prevent overturning when releasing the valve. Don't rotate the hexagon under any circumstances. To open the drain valve, there is a loosening screw with notches around the circumference, which is operated manually. The valve opens counterclockwise and closes clockwise.

FV PPR ball valve with threaded elbow for hose connection

System: **AQUA**
 Material: PP-R - brass
 Standard: ČSN EN ISO 15874

Note: A plastic tap for garden purposes.

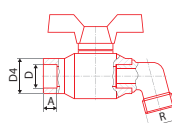

Icon	⊕	⊞	⊞	⊞	dm³	# ●	# ●	# ●	D [mm]	D4 [mm]	A [mm]	B [mm]	G
20	pcs	40	1	0,14	0,39	AA273020000	BA273020000		20	31,2	14,5	96	3/4"
25	pcs	30	1	0,15	0,77	AA273025000	BA273025000		25	37,4	16,0	117	1"

FV PPR valve with threaded elbow for hose connection

System: **AQUA**
 Material: PP-R - brass
 Standard: ČSN EN ISO 15874

Note: Valve with threaded elbow for hose connection to garden irrigation systems.

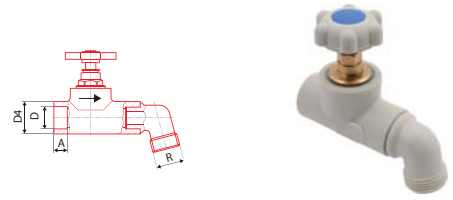

mm	+	+	+	+	dm³	# ●	# ●	# ●	D [mm]	D4 [mm]	A [mm]	B [mm]	G
20	pcs	50	10	0,17	0,65	AA276020000	BA276020000		20	30,0	14,5	112,5	3/4"
25	pcs	40	10	0,24	0,68	AA276025000	BA276025000		25	37,3	16,0	125,0	1"

FV PPR straight-way valve

System: **AQUA**
 Material: PP-R - brass
 Standard: ČSN EN ISO 15874

Note: A valve allowing closing or regulation of the flow of water.

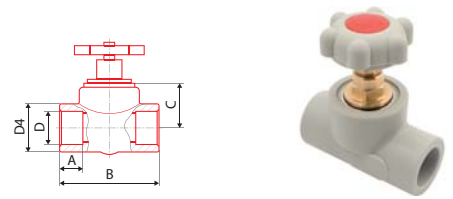

mm	+	+	+	+	dm³	# ●	# ●	# ●	D [mm]	D4 [mm]	A [mm]	B [mm]	C [mm]
20	pcs	60	10	0,15	0,60	AA274020000	BA274020000		20	30	14,5	76,0	26
25	pcs	40	10	0,21	0,60	AA274025000	BA274025000		25	37	16,0	83,5	35
32	pcs	30	5	0,32	0,96	AA274032000	BA274032000		32	46	18,0	94,0	38
40	pcs	20	2	0,40	1,07	AA274040000	BA274040000		40	60	20,5	107,0	38
50	pcs	10	1	0,75	1,92	AA274050000	BA274050000		50	71	23,5	135,0	56
63	pcs	6	1	1,29	2,10	AA274063000	BA274063000		63	84	27,5	160,0	60

FV PPR straight-way valve with PV valve

System: **AQUA**
 Material: PP-R - brass
 Standard: ČSN EN ISO 15874

Note: A valve allowing closing or regulation of the flow of water.

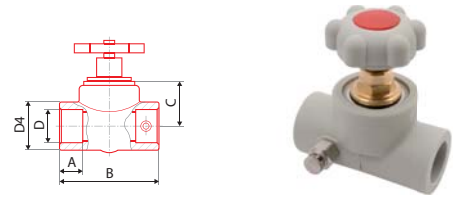

mm	+	+	+	+	dm³	# ●	# ●	# ●	D [mm]	D4 [mm]	A [mm]	B [mm]	C [mm]
20	pcs	50	10	0,17	0,60	AA275020000	BA275020000		20	30	14,5	76,0	26
25	pcs	40	10	0,24	0,60	AA275025000	BA275025000		25	37	16,0	83,5	35
32	pcs	30	2	0,35	0,96	AA275032000	BA275032000		32	46	18,0	94,0	38
40	pcs	20	2	0,42	1,07	AA275040000	BA275040000		40	60	20,5	107,0	38

FV PPR back flow valve

System: **AQUA**
 Material: PP-R - brass
 Standard: ČSN EN ISO 15874

Note: For prevention of back flow.

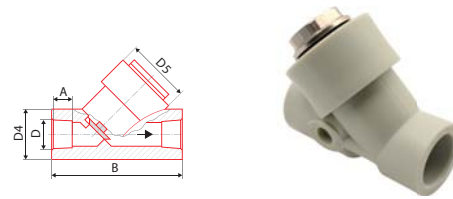

mm	+	+	+	+	dm³	# ●	# ●	# ●	D [mm]	D4 [mm]	D5 [mm]	A [mm]	B [mm]
20	pcs	40	1	0,19	0,25	AA281020034	BA281020034		20	35,3	46,8	14,5	83,6
25	pcs	40	1	0,19	0,25	AA281025034	BA281025034		25	35,3	46,8	16,0	83,6
32	pcs	40	1	0,16	0,56	AA281032000	BA281032000		32	42,0	46,8	18,0	94,0

FV PPR filter

System: **AQUA**
 Material: PP-R - brass
 Standard: ČSN EN ISO 15874
 Note: Combined fitting with stainless strainer.

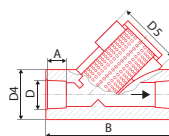

Q _{min}	☉	☐	☐	☐	dm ³	# ●	# ●	# ●	D [mm]	D4 [mm]	D5 [mm]	A [mm]	B [mm]
20	pcs	40	1	0,17	0,36	AA282020000	BA282020000		20	35,3	46,8	14,5	83,6
25	pcs	40	1	0,17	0,36	AA282025000	BA282025000		25	35,3	46,8	16,0	83,6
32	pcs	40	1	0,25	0,54	AA282032000	BA282032000		32	42,0	46,8	18,0	94,0

FV PPR shut off valve lux straight with chrome handle

System: **AQUA**
 Material: PP-R - brass
 Standard: ČSN EN ISO 15874
 Note: Spare part for straight-way valve.

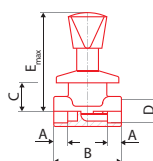

Q _{min}	☉	☐	☐	☐	dm ³	# ●	# ●	# ●	D, D4 [mm]	A [mm]	B [mm]	C [mm]	Emax [mm]
20	pcs	15	1	0,25		AA285020000	BA285020000		20/36	14,5	76,0	26	105
25	pcs	12	1	0,30		AA285025000	BA285025000		25/37,3	16,0	83,5	35	115

FV PPR shut off valve straight with cover

System: **AQUA**
 Material: PP-R - brass
 Standard: ČSN EN ISO 15874
 Note: An elegant above-plaster valve for closing branches of a distribution system.

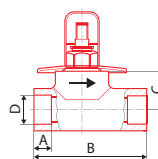

Q _{min}	☉	☐	☐	☐	dm ³	# ●	# ●	# ●	D [mm]	A [mm]	B [mm]	C [mm]	
20*	pcs	20	1	0,17		AA286020000	BA286020000		metal sh.	20	15	75,6	26
20L*	pcs	20	1	0,17		AA286020100	BA286020100		metal lo.	20	15	75,6	25
25	pcs	15	1	0,21		AA286025000	BA286025000		metal sh.	25	16	83,3	36
25L	pcs	15	1	0,21		AA286025100	BA286025100		metal lo.	25	16	83,3	35
20	pcs	20	1	0,17		AA287020000	BA287020000		plastic sh.	20	15	75,6	26
20L	pcs	20	1	0,17		AA287020100	BA287020100		plastic lo.	20	15	75,6	26
25	pcs	15	1	0,21		AA287025000	BA287025000		plastic sh.	25	16	83,3	34
25L	pcs	15	1	0,21		AA287025100	BA287025100		plastic lo.	25	16	83,3	36

FV PPR inside the valve

System: **AQUA**
 Material: Brass
 Standard:
 Note: Spare part for straight-way valve.



Q _{min}	☉	☐	☐	☐	dm ³	#	D [mm]	description
20	pcs		1			AA288020001	20	short d20
20	pcs		1			AA288020002	20	long (Laguna) d20
25	pcs		1			AA288025001	25	short d25
25	pcs		1			AA288025002	25	long (Laguna) d25
32	pcs		1			AA288032001	32	short d32

FV PP-RCT FITTINGS FOR BUTT WELDING

FV PP-RCT butt welding elbow 90°

System: **AQUA**
 Material: PP-RCT
 Standard: ČSN EN ISO 15874

Note: A simple, reliable fitting for changing the pipeline direction.

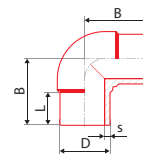

Icon	⊕	⊞	⊠	⊡	dm³	#	D [mm]	Z [mm]	L [mm]	
	160	pcs		1	3,0	9	BA202160000	160	212	110
	200	pcs		1	5,4	20	BA202200000	200	255	127
	250	pcs		1	9,5	30	BA202250000	250	294	140

FV PP-RCT butt welding elbow 45°

System: **AQUA**
 Material: PP-RCT
 Standard: ČSN EN ISO 15874

Note: A simple, reliable fitting for changing the pipeline direction.

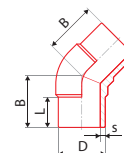

Icon	⊕	⊞	⊠	⊡	dm³	#	D [mm]	Z [mm]	L [mm]	
	160	pcs		1	2,42	7	BA203160000	160	168	110
	200	pcs		1	4,44	16	BA203200000	200	217	127
	250	pcs		1	7,66	25	BA203250000	250	223	140

FV PP-RCT butt welding reduction

System: **AQUA**
 Material: PP-RCT
 Standard: ČSN EN ISO 15874

Note: A simple, reliable fitting for dimension change of pipeline.

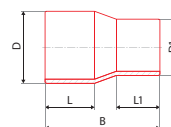

Icon	⊕	⊞	⊠	⊡	dm³	#	D [mm]	D1 [mm]	Z [mm]	L [mm]	L1 [mm]	
	160 x 110	pcs		1	1,14	5	BA210160110	160	110	255	110	93
	160 x 125	pcs		1	1,16	5	BA210160125	160	125	255	110	97
	200 x 160	pcs		1	2,61	9	BA210200160	200	160	275	122	100
	250 x 160	pcs		1	3,95	14	BA210250160	250	160	330	137	111
	250 x 200	pcs		1	4,45	15	BA210250200	250	200	330	137	128

FV PP-RCT electro-fusion socket

System: **AQUA**
 Material: PP-RCT
 Standard: ČSN EN ISO 15874

Note: A fitting for pipe connection under electro-fusion welding condition.

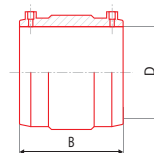

Icon	⊕	⊞	⊠	⊡	dm³	#	D [mm]	L [mm]	
	160	pcs		1	1,82	5	BA234160000	160	175
	200	pcs		1	2,58	9	BA234200000	200	185
	250	pcs		1	4,42	14	BA234250000	250	213

FV PP-RCT butt welding tee

System: **AQUA**
 Material: PP-RCT
 Standard: ČSN EN ISO 15874

Note: A simple, reliable fitting for branching the pipeline.

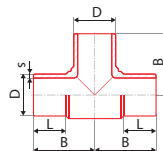

Obrazek	Symbol	Skupina	Objem	hm	dm ³	#	D [mm]	B [mm]	s [mm]	L [mm]
160	pcs	1	3,99	12	12	BA208160000	160	225	14,6	124
200	pcs	1	7,38	18	18	BA208200000	200	251	18,2	127
250	pcs	1	9,80	23	23	BA208250000	250	314	22,7	148

FV PP-RCT polyfusion/butt welding tee reduced

System: **AQUA**
 Material: PP-RCT
 Standard: ČSN EN ISO 15874

Note: A simple, reliable fitting for branching the pipeline

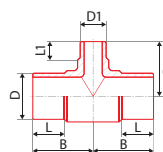

Obrazek	Symbol	Skupina	Objem	hm	dm ³	#	D [mm]	D1 [mm]	Z [mm]	L [mm]	L1 [mm]
160 x 90 x 160	pcs	1	3,20	9	9	BA212160090	160	90	212	110	85
160 x 110 x 160	pcs	1	3,34	10	10	BA212160110	160	110	212	110	95
200 x 90 x 200	pcs	1	6,20	14	14	BA212200090	200	90	255	127	95
200 x 110 x 200	pcs	1	6,40	15	15	BA212200110	200	110	255	127	95
200 x 125 x 200	pcs	1	6,80	16	16	BA212200125	200	125	255	127	100
200 x 160 x 200	pcs	1	7,12	17	17	BA212200160	200	160	255	127	110

FV PP-RCT butt welding blinding

System: **AQUA**
 Material: PP-RCT
 Standard: ČSN EN ISO 15874

Note: For permanent or temporary blinding of a branch.

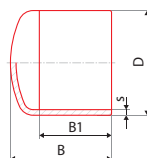

Obrazek	Symbol	Skupina	Objem	hm	dm ³	#	D [mm]	s [mm]	B [mm]	B1 [mm]
160	pcs	1	0,90	2,9	2,9	BA229160000	160	14,6	140	100
200	pcs	1	2,03	6,2	6,2	BA229200000	200	18,2	190	145
250	pcs	1	3,18	12,7	12,7	BA229250000	250	22,7	218	263

FV PP-RCT weld in saddle polyfusion

System: **AQUA**
 Material: PP-RCT
 Standard: ČSN EN ISO 15874

Note: For additional branches from existing pipeline.

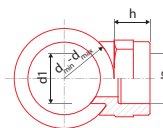

Obrazek	Symbol	Skupina	Objem	hm	dm ³	#	dmin [mm]	dmax [mm]	d1 [mm]	d2 [mm]	h [mm]
125 x 32	pcs	1	0,04	0,4	0,4	BA238125032	75	125	32	32	35
125 x 40	pcs	1	0,04	0,4	0,4	BA238125040	75	125	40	40	38
125 x 50	pcs	1	0,04	0,4	0,4	BA238125050	110	125	50	50	39
125 x 63	pcs	1	0,04	0,4	0,4	BA238125063	125	125	63	63	45
160-250 x 20	pcs	1	0,04	0,4	0,4	BA238160020	160	250	20	20	29
160-250 x 25	pcs	1	0,04	0,4	0,4	BA238160025	160	250	25	25	29
160-250 x 32	pcs	1	0,04	0,4	0,4	BA238160032	160	250	32	32	35
160-250 x 40	pcs	1	0,04	0,4	0,4	BA238160040	160	250	40	40	38
160-250 x 50	pcs	1	0,04	0,4	0,4	BA238160050	160	250	50	50	39
160-250 x 63	pcs	1	0,04	0,4	0,4	BA238160063	160	125	63	63	45

FV PP-RCT weld in saddle with metal male thread polyfusion

System: **AQUA**
 Material: PP-RCT - brass
 Standard: ČSN EN ISO 15874
 Note: Transition fitting from plastic part to metal part of pipeline, for additional branches.

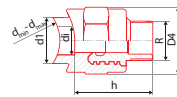

Objekt	Symbol	Skupina	Podskupina	Objekt	Objekt	Objekt	#	dmin [mm]	dmax [mm]	d1 [mm]	R	h [mm]	di [mm]	D4 [mm]
160-250 x 25 x 1/2"	pcs	1	1	0,132	0,048	BM248160025	160	250	25	1/2"	42	15	38	
160-250 x 32 x 3/4"	pcs	1	1	0,116	0,100	BM248160032	160	250	32	3/4"	49	20,5	51	
160-250 x 40 x 1"	pcs	1	1	0,234	0,168	BM248160040	160	250	40	1"	54	25,5	63	
160-250 x 40 x 5/4"	pcs	1	1	0,234	0,168	BM248160041	160	250	40	1 1/4"	54	25,5	63	
160-250 x 50 x 5/4"	pcs	1	1	0,330	0,227	BM248160050	160	250	50	1 1/4"	59	32	70	
160-250 x 50 x 6/4"	pcs	1	1	0,350	0,227	BM248160051	160	250	50	1 1/2"	59	34	70	
160-250 x 63 x 2"	pcs	1	1	0,632	0,255	BM248160063	160	250	63	2"	45	40	85	

FV PP-RCT weld in saddle with metal female thread polyfusion

System: **AQUA**
 Material: PP-RCT - brass
 Standard: ČSN EN ISO 15874
 Note: Transition fitting from plastic part to metal part of pipeline, for additional branches.

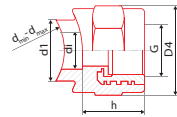

Objekt	Symbol	Skupina	Podskupina	Objekt	Objekt	Objekt	#	dmin [mm]	dmax [mm]	d1 [mm]	G	h [mm]	di [mm]	D4 [mm]
160-250 x 25 x 1/2"	pcs	1	1	0,060	0,03	BM247160025	160	250	25	1/2"	29	15	38	
160-250 x 32 x 3/4"	pcs	1	1	0,102	0,07	BM247160032	160	250	32	3/4"	35	20,5	51	
160-250 x 40 x 1"	pcs	1	1	0,194	0,12	BM247160040	160	250	40	1"	38	25,5	63	
160-250 x 40 x 5/4"	pcs	1	1	0,194	0,12	BM247160041	160	250	40	1 1/4"	38	25,5	63	
160-250 x 50 x 5/4"	pcs	1	1	0,240	0,15	BM247160050	160	250	50	1 1/4"	39	32	70	
160-250 x 50 x 6/4"	pcs	1	1	0,244	0,15	BM247160051	160	250	50	1 1/2"	39	34	70	
160-250 x 63 x 2"	pcs	1	1	0,490	0,26	BM247160063	160	250	63	2"	45	40	85	

FV PP-RCT butt welding flange adaptor

System: **AQUA**
 Material: PP-RCT
 Standard: ČSN EN ISO 15874
 Note: Plastic fitting for flange dismountable joints.

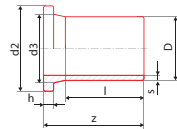

Objekt	Symbol	Skupina	Podskupina	Objekt	Objekt	Objekt	#	D [mm]	l [mm]	z [mm]	d2 [mm]	d3 [mm]	h [mm]	s [mm]
160/150	pcs		1	1,2	3,8	BA230160150	160	110	175	212	175	25	14,6	
200/200	pcs		1	1,89	4,7	BA230200200	200	127	205	268	232	32	18,2	
250/250	pcs		1	2,67	5,8	BA230250250	250	146	235	320	285	35	22,7	

FV PP-RCT flange plastic covered

System: **AQUA**
 Material: plastic coated steel
 Standard:
 Note: Metal fitting for flange dismountable joints.

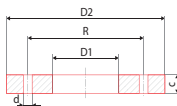

Objekt	Symbol	Skupina	Podskupina	Objekt	Objekt	Objekt	#	D1 [mm]	D2 [mm]	R [mm]	d	c [mm]	number of holes
160/150	pcs		1	2,80	1,53	BA231160150	178	285	240	M16	24	8	
200/200	pcs		1	3,77	2,18	BA231200200	235	340	295	M16	24	8	
250/250	pcs		1	6,04	4,01	BA231250250	288	406	350	M16	31	12	

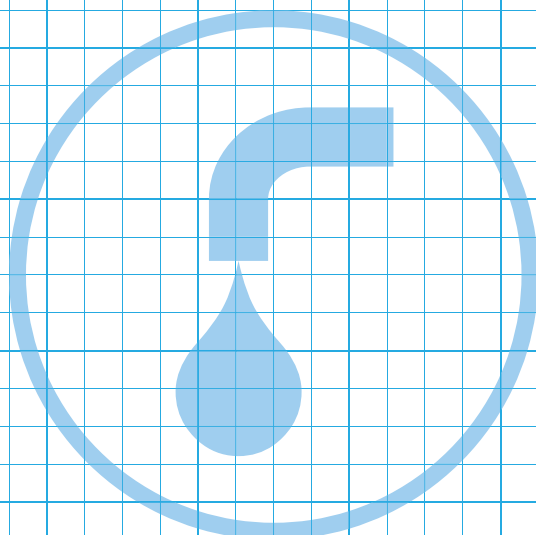

TOOLS FOR FV AQUA PPR AND PP-RCT SYSTEM

Welding machine 650 W for non-paired adapter $\varnothing 16 - \varnothing 63$

Welding machine for non-paired adapter, electronics adjustment (SE 22). Offered also as a set with a case.



Icon	⊕	⊞	⊞	⊞	dm ³	#	P [W]	
SE 22	pcs	1	1	1,28	6,14	AA401003650	650	electronic regulation

Welding machine 850 W for paired adapter $\varnothing 16 - \varnothing 75$

New generation of welding machine for paired adapter, electronics adj. (SE 42). The SE 42 is equipped with precise electronic regulation. Suitable for welding of larger pipe diameters, fast heat up time.



Icon	⊕	⊞	⊞	⊞	dm ³	#	P [W]	
SE 42	pcs	1	1	1,32	6,14	AA402004850	850	electronic regulation

Dytron Welder Polys P-4 650 W

A welding machine by a renowned Czech producer.



Icon	⊕	⊞	⊞	⊞	dm ³	#	P [W]	
P-4a	pcs	1	1	1,60	6,21	AA403001650	650	thermostat
P-4b	pcs	1	1	2,00	6,21	AA403002650	650	electronic regulation

Dytron Welder Polys P-4 850 W

A welding machine by a renowned Czech producer.



Icon	⊕	⊞	⊞	⊞	dm ³	#	P [W]	
P-4a	pcs	1	1	2,00	6,21	AA404001850	850	electronic regulation

Dytron Welder Polys P-4 1200 W

For welding of large dimensions up to 125 mm, we offer a flat welder with a power input of 1200 W. The manual welder is designed for professionals, it is equipped with precise electronic control and, depending on the type, the original acoustic weld guide TraceWeld. Its biggest advantage is the possibility of continuous operation, even in demanding conditions.



Icon	⊕	⊞	⊞	⊞	dm ³	#	P [W]	
P-4a	pcs	1	1	2,10	6,21	AA405001120	1200	electronic regulation

Dytron Welder Polys P-1b 500 W

The specialty of the welder P-1b in this category is angle design, which allows you to work in confined spaces.



						#	P [W]	
P-1b	pcs	1	1	1,6	6,21	AA406001500	500	thermostat

Mini set SE 22

Practical set for socket welding designed for hobbyists and unpretentious Professionals. Traditional metal case please durability and welder his life. Contents: thorns welder SE 22, jaw adaptors ø 20, 25 and 32 mm, metal case MINI, scissors, stand, 4 mm Allen key.



						#	P [W]	
SE 22	set	1	1	5,12	8,52	AA407003022	650	electronic regulation

Mini set SE 42

Practical set for socket welding designed for hobbyists and unpretentious Professionals. Traditional metal case please durability and welder his life. Contents: flat welder SE 42, jaw adaptors ø 20, 25, 32 and 40 mm, metal case MINI, scissors, stand, 4 mm Allen key.



						#	P [W]	
SE 42	set	1	1	5,40	8,52	AA408001042	850	electronic regulation

Profi set SE 22

Practical professional set for socket welding designed for all-day use in the most demanding craftsmen. Robust metal suitcase please durability and welder his life. Contents: 22 SE thorns welder, jaw adaptors ø 20, 25, 32, 40, 50, 63 mm metal case PROFI, foot stand, scissors DYNO, 4 mm Allen key.



						#	P [W]	
SE 22	set	1	1	8,26	16,58	AA409000022	650	electronic regulation

Profi set SE 42

Practical professional set for socket welding designed for all-day use in the most demanding craftsmen. Robust metal case please durability and welder his life. Contents: 41 SE thorns welder, jaw adaptors ø 20, 25, 32, 40, 50, 63 mm metal case PROFI, foot stand, scissors DYNO, 4 mm Allen key.



						#	P [W]	
SE 42	set	1	1	8,30	16,58	AA410000042	850	electronic regulation

Adapter paired for SE 42 black

Pair adapter can only be used for flat welder. Pair adapters enable welding of pipes from the lowest diameters d16 to d125. Depending on the size, one or two adapters can be mounted on the welder at one time.



Q ₁₁₁	⊕	⊞	⊞	⊞	dm ²	#
16	set	1	1	0,06	0,03	AA411016000
20	set	1	1	0,06	0,03	AA411020000
25	set	1	1	0,10	0,06	AA411025000
32	set	1	1	0,18	0,10	AA411032000
40	set	1	1	0,23	0,14	AA411040000
50	set	1	1	0,34	0,20	AA411050000
63	set	1	1	0,63	0,32	AA411063000
75	set	1	1	0,84	0,45	AA411075000
90	set	1	1	1,52	0,73	AA411090000
110	set	1	1	1,70	1,69	AA411110000
125	set	1	1	1,92	2,13	AA411125000

Adapter paired for SE 42 blue

Pair adapter can only be used for flat welder. Pair adapters enable welding of pipes from the lowest diameters d16 to d125. Depending on the size, one or two adapters can be mounted on the welder at one time.



Q ₁₁₁	⊕	⊞	⊞	⊞	dm ²	#
20	set	1	1	0,06	0,03	AA411020001
25	set	1	1	0,10	0,06	AA411025001
32	set	1	1	0,18	0,10	AA411032001
40	set	1	1	0,23	0,14	AA411040001
50	set	1	1	0,34	0,20	AA411050001
63	set	1	1	0,63	0,32	AA411063001
75	set	1	1	0,84	0,45	AA411075001
90	set	1	1	1,52	0,73	AA411090001
110	set	1	1	1,70	1,69	AA411110001

Adapter paired for weld in saddle

Pair adapters can only be used for flat welder. Allow welding additional seats branches from d 25 to d 63 to pipes from d 63 to d 250.



Q ₁₁₁	⊕	⊞	⊞	⊞	dm ²	#
63 × 32	set	1	1	0,300	0,137	AA412063032
75 × 32	set	1	1	0,300	0,137	AA412075032
90 × 32	set	1	1	0,300	0,137	AA412090032
110 × 32	set	1	1	0,300	0,137	AA412110032
110 × 40	set	1	1	0,300	0,137	AA412110040
75-125 × 25	set	1	1	0,280	0,655	AA412125025
75-125 × 32	set	1	1	0,410	0,655	AA412125032
75-125 × 40	set	1	1	0,230	0,655	AA412125040
75-125 × 50	set	1	1	0,230	0,655	AA412125050
75-125 × 63	set	1	1	1,164	2,639	AA412125063
160-250 × 25	set	1	1	0,170	0,160	AA412160025
160-250 × 32	set	1	1	0,230	0,160	AA412160032
160-250 × 40	set	1	1	0,360	0,160	AA412160040
160-250 × 50	set	1	1	0,650	0,160	AA412160050
160-250 × 63	set	1	1	1,040	0,160	AA412160063

Drill for weld in saddle

Necessary tool to create the correct hole for inserting the weld in saddle.



						#
25	pcs	1	1	0,164	0,10	AA414025000
32	pcs	1	1	0,228	0,10	AA414032000
40	pcs	1	1	0,256	1,10	AA414040000
50	pcs	1	1	0,347	0,46	AA414050000
63	pcs	1	1	0,466	0,46	AA414063000

Adapter non-paired for SE 22 black

Non pair adapters enable welding of pipes from the lowest diameters d16 to d63. Depending on the size, one to three adapters can be mounted on the welder at one time.



						#
16	pcs	1	1	0,13	0,13	AA415016000
20	pcs	1	1	0,15	0,15	AA415020000
25	pcs	1	1	0,16	0,19	AA415025000
32	pcs	1	1	0,17	0,30	AA415032000
40	pcs	1	1	0,30	0,41	AA415040000
50	pcs	1	1	0,40	0,57	AA415050000
63	pcs	1	1	0,77	0,85	AA415063000

Adapter non-paired for SE 22 blue

Non pair adapters enable welding of pipes from the lowest diameters d16 to d63. Depending on the size, one to three adapters can be mounted on the welder at one time.



						#
16	pcs	1	1	0,13	0,13	AA415016001
20	pcs	1	1	0,11	0,15	AA415020001
25	pcs	1	1	0,14	0,19	AA415025001
32	pcs	1	1	0,22	0,30	AA415032001
40	pcs	1	1	0,325	0,41	AA415040001
50	pcs	1	1	0,480	0,57	AA415050001
63	pcs	1	1	0,725	0,85	AA415063001

Repairing set

Allows easy repair of the pipe in case of accidental drilling without the need to replace the pipe in the wall. It can only be used with rod welders. Watch the instructional video before use.



						#
	set	1	1	0,20		AA418000000

Repairing stake

Consumables for repair kit.



						#
	set	1	5	0,03		AA419000000

Pipe cutter REMS

A quality tool for reliable cutting of larger pipes from a renowned European supplier.



Icon	Unit	Quantity	Weight	Volume	Length	Code
	pcs	1	1,20	3,65		AA423000000

Shears

Quality tested tools made of light alloys with sufficient power and operator comfort for professional cutting of PPR, PP-RCT, PE-RT and HDPE pipes of all supplied dimensions.



Icon	Unit	Quantity	Weight	Volume	Length	Code
	pcs	15	0,34	0,96		AA424032000
	pcs	10	0,42	0,96		AA424040000
	pcs	2	1,17	3,17		AA424063000

Tightening spanner with belt

Necessary tool for correct fixing and tightening of fittings containing a sprayed brass thread in the plastic part.



Icon	Unit	Quantity	Weight	Volume	Length	Code
	pcs	20	0,33	0,72		AA425000000

Spiral for sewer cleaning

Practical helper of all plumbers.



Icon	Unit	Quantity	Weight	Volume	Length	Code
	pcs	1	0,64	1,88		AA426000003
	pcs	1	1,21	2,50		AA426000005
	pcs	1	4,73	6,48		AA426000010
	pcs	1	9,40	10,11		AA426000020
	pcs	1	11,93	11,55		AA426000025

Assembly MP 75

Light fixation apparatus operated by a lever, with infinitely adjustable clamping jaws provide a firm grip and mutual welding fittings and pipes with 40-75mm. The advantage of this device is a low weight, which can be further reduced by removing the clamping jaws, it is therefore advantageous with this device works in positional welds, e.g. under the ceiling.



Icon	Unit	Quantity	Weight	Volume	Code	
	pcs	1	22,00	160,00		AA427040075

Assembly MP 110 UD

Robust professional equipment designed for socket welding of pipes and fittings up to dimension 110mm. The set comes with a set of necessary accessories, which is stored in a practical case. Set includes: clamping slide (including selected fixtures) welder POLYS P-4a 1250 W, paired adapters of DT coatings 40, 50, 63, 75, 90 and 110 mm, inserts according to the selected design, stand welder, centering pin, clamping inserts, metal case for accessories, allen keys 5, 6, 8mm.



						#
40-110	pcs	1	1	47,00	240,00	AA428040110

Assembly Spider 125

The Spider is lightweight ideal equipment for quick and accurate socket fusion of polypropylene pipe and fittings from 63 mm to 125 mm. The Spider is delivered in a robust, rugged stainless steel case. The product itself has a low weight, only 7,5 kg. The Spider is ideal for performing socket fusions overhead, vertically and other tight indoor spaces from the attic to the floor. Note: The green stand is not included. It can be ordered separately under the name Spider Demo stand.



						#
39 x 51 x 24 cm	pcs	1	1	14,6	47,74	AA428050125

Case for welding machine PROFI

If you decide to build your PRO kit for socket welding gradually, a rugged metal case will be suitable.



						#
PROFI SE22	pcs	1	1	4,8	16,9	AA417001022
PROFI SE42	pcs	1	1	4,8	16,9	AA417002042

Case for welding machine MINI

Robust sheet metal case for MINI set.



						#
MINI SE22	pcs	1	1	2,9	9,09	AA417003022
MINI SE42	pcs	1	1	2,9	9,09	AA417004042



ASSEMBLY INSTRUCTIONS FOR FV AQUA PPR AND PP-RCT

1. SYSTEM USE

The FV AQUA PPR and PP-RCT system enables the implementation of distribution in residential buildings, administrative and public buildings, industry and agriculture.

It is designed for the transport of cold and hot water and in compliance with the prescribed rules for central heating. For individual applications, it is necessary to select a suitable type of pipe with the corresponding parameters of the operating temperature and pressure limits. The FV AQUA system offers PPR, PP-RCT HOT, PP-RCT UNI, PP-RCT FASER, PP-RCT FASER COOL and PP-RCT FASER HOT pipes.

The system can also be used for air distribution. The possibility of conducting other liquid, gaseous or solid substances must be assessed in each specific case.

All pipes can be connected with a comprehensive range of PPR fittings connected by polyfusion welding (up to 125 mm in diameter) or butt welding (diameters from 160mm)

Water distribution

The system can be used for all internal water pipes (cold water, utility water, hot water, hot water for circulation). The plastic piping system is expected to last 50 years with the right choice of material, pipe type and application.

The type of pipe, depending on the hot water heating system and its temperature regulations is chosen by a project architect. In hot water distribution systems, the maximum water temperature at the outlet battery is assumed to be 57 °C as protection against scalding and in the distribution systems there is a possibility of short-term overheating of hot water to higher temperatures (70 °C) at the heating point for hygienic reasons, especially elimination of pathogens.

Heating distribution

When assessing the suitability of a specific type of heating pipe, it is necessary to use the value of the inlet calculated heating water temperature, which is the highest temperature that occurs in the system. The project architect of the heating system chooses it depending on the required temperature at the inlet to the radiators, according to the technical possibilities of the heat source and the type of expansion vessel

Recommended values for heating			
temperature range			
70/50 °C	70/60 °C	75/65 °C	80/60 °C
and for low temperature systems			

When installing plastic pipes behind a boiler we recommend installing 1.5 - 2 m of metal pipes as an added protection in case of the system overheating.

The method of leading the pipes is same for either water or heat distribution. The basic requirements are the provision of mechanical protection of the pipeline and the provision of pipeline support and expansion joint compensation

Piping can be led:

- in the grooves of the walls
- in installation partitions (pre-wall mounting)
- in floors, ceilings
- along the walls (freely or in covers)
- in installation shafts and sewerages
- under plaster
- in plasterboard partitions and ceilings

Piping outside the building must be assessed according to specific conditions.

2. ASSEMBLY INSTRUCTION

2.1. Warning:

Only elements that have not been damaged or soiled during transport and storage may be used.

The minimum temperature for the assembly of plastic pipes is with regard to welding

+5 °C. At lower temperatures, it is difficult to ensure the conditions for creating quality joints.

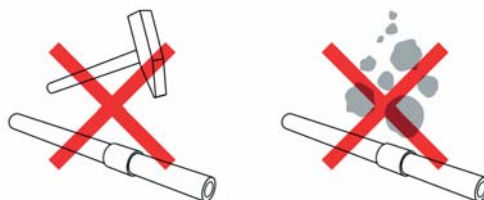

Throughout assembly and transport, the elements of the plastic system must be protected against impacts, shocks, falling materials and other forms of mechanical damage.



Pipe bending is performed without heating at a temperature of at least + 15 °C. For pipes with a diameter of 16 - 32 mm, the minimum bending radius is 8 times the pipe diameter (D).

It is not permissible to bend the pipes by heating with open flame or hot air.

Pipe crossing is done with special fittings for this purpose.

Joining of plastic parts is performed by polyfusion welding, further welding by using electric fittings and butt welding. During welding, a homogeneous joint of high quality is created. The exact procedure must be followed and suitable tools must be used.



Metal threaded fittings must be used for permanent threaded connections. Threading plastic elements is prohibited. The threads are sealed with Teflon tape, sealing thread or special sealants.

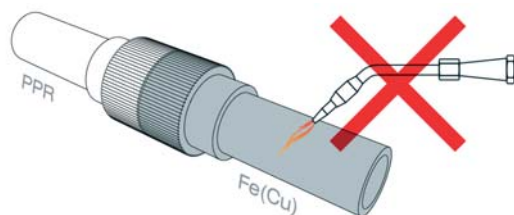

If the combined fitting is followed by a metal pipe, it cannot be connected by soldering or welding in the vicinity of the fitting due to the possible heat transfer to the fitting.

For temporary or short-term closure of wall elbows or universal wall sets before installation of outlet fittings, we recommend using plastic plugs (plastic plugs are intended for temporary use only - eg pressure test). Metal threaded plugs must be used for long-term sealing.

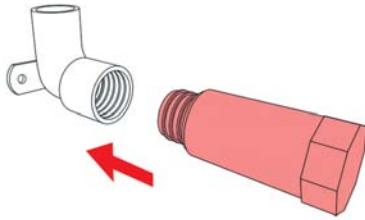

2.2 Longitudinal expansion and contraction

The difference between the temperatures during installation and during operation, when a medium with a different temperature than the temperature during installation is transported in the pipeline, causes length changes - lengthening or shortening (Δl).

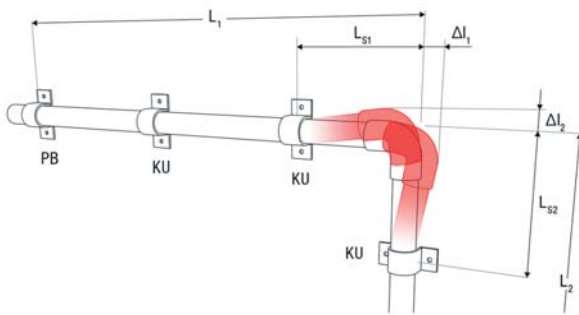

$$\Delta l = \alpha \cdot L \cdot t \text{ [mm]}$$

- Δl length change [mm]
- α coefficient of thermal longitudinal expansion [mm / m ° C], for all-plastic pipe design PP-R and PP-RCT $\alpha = 0,15$ | for FASER $\alpha = 0.05$
- L calculated length (distance of two adjacent fixed points in a straight line) [m]
- t temperature difference during installation and operation [° C]

$$L_s = k \cdot \sqrt{(D \cdot \Delta l)} \text{ [mm]}$$

- L_s free compensation length
- k material constant, for PPR $k = 20$
- D outer pipe diameter [mm]
- Δl length change [mm] calculated from the previous formula

U - compensator

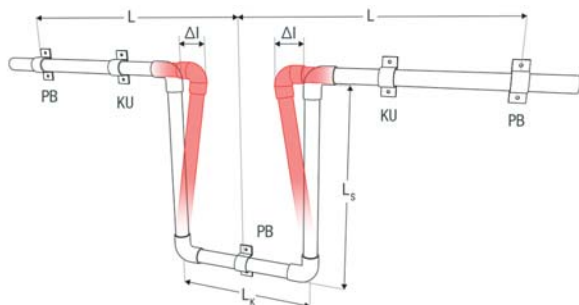

- PB Fixed point
- KU Siding point
- L Calculated pipe length
- L_s Compensation length
- Δl length change [mm]
- L_k compensator width

$$L_k = 2 \cdot \Delta l + 150 \text{ [mm]} \text{ and at the same time } L_k \geq 10 \cdot D$$

- L_k compensator width
- Δl length change [mm]
- D outer pipe diameter [mm]

Appropriate compensation method: the pipe is deflected in a direction perpendicular to the original route and a free compensation length (designation L_s) is left on this perpendicular, which ensures that significant additional compressive and tensile stresses do not occur in the pipe wall when dilating the straight route. The compensation length L_s depends on the calculated lengthening (shortening) of the route, material and pipe diameter.

Polypropylene uses the flexibility of the material to compensate for length changes. In addition to compensation in the bending of the pipeline, bending "U" compensators and compensation loops are used.

The value of the length change Δl can also be read from the graphs.

Chart for installation of FV PPR compensation loop

Pipe diameter [mm]	Distance of fixed points L [m]	
	FASER	PPR and PP-RCT
16	24	8
20	27	9
25	30	10
32	36	12
40	42	14

FV PPR compensation loop

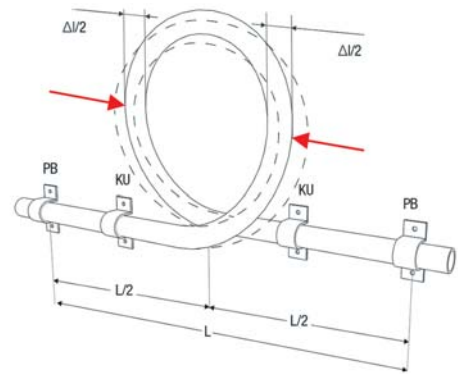

Before welding the FV PPR compensation loop, press it in the direction of the arrows and weld it by pressing the calculated value Δl .

- PB Fixed point
- KU Siding point
- L Calculated pipe length

Example of compensation by changing the route adapted to the building structure

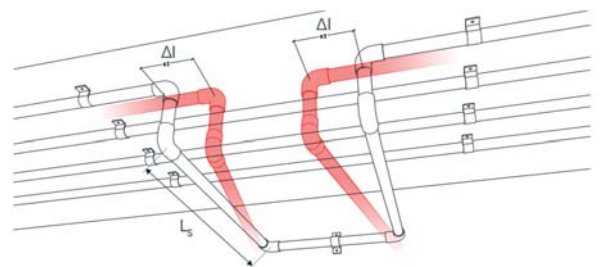

"U" compensator

The calculated free length L_s means the length without any fixed supports or hinges that would prevent expansion. The free length L_s should not exceed the maximum distance of the supports depending on the pipe diameter and the medium temperature.

Length extension: all-plastic pipes PPR and PP-RCT

Example: L = 8 m, $\Delta t = 46^\circ\text{C}$

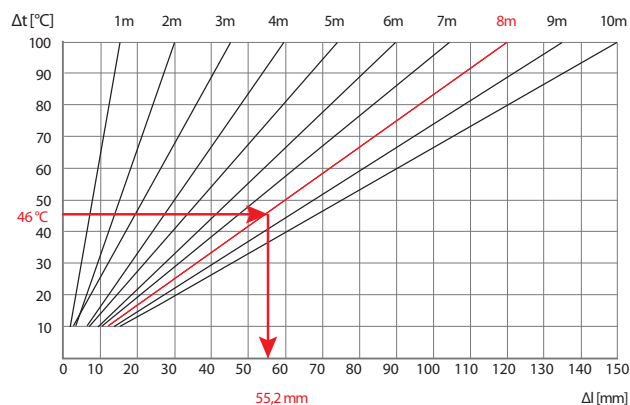

Pipe length [m]	Temperature difference Δt							
	10 °C	20 °C	30 °C	40 °C	50 °C	60 °C	70 °C	80 °C
	length change [mm]							
1	1,5	3	5	6	8	9	11	12
2	3	6	9	12	15	18	21	24
3	5	9	14	18	23	27	32	36
4	5	9	14	18	23	27	32	36
5	8	15	23	30	38	45	53	60
6	9	18	27	36	45	54	63	72
7	11	21	32	42	53	63	74	84
8	12	24	36	48	60	72	84	96
9	14	27	41	54	68	81	95	108
10	15	30	45	60	75	90	105	120
15	23	45	68	90	113	135	158	150

Length extension: FASER pipes

Example: L = 10 m, $\Delta t = 40^\circ\text{C}$

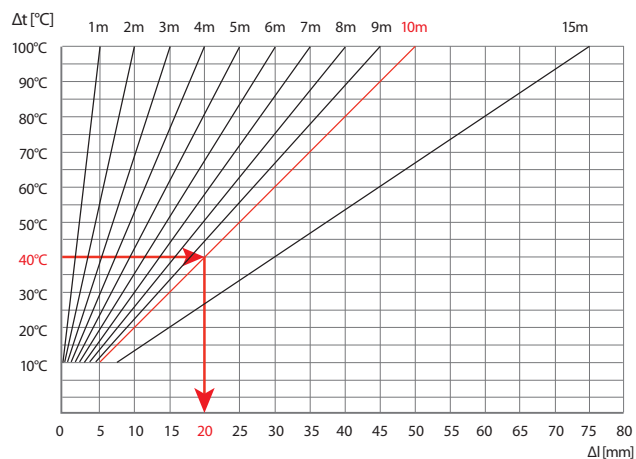

Pipe length [m]	Temperature difference Δt							
	10 °C	20 °C	30 °C	40 °C	50 °C	60 °C	70 °C	80 °C
	length change [mm]							
1	1	1	2	2	3	3	4	4
2	1	2	3	4	5	6	7	8
3	2	3	5	6	8	9	11	12
4	2	4	6	8	10	12	14	16
5	3	5	8	10	13	15	18	20

6	3	6	9	12	15	18	21	24
7	4	7	11	14	18	21	25	28
8	4	8	12	16	20	24	28	32
9	5	9	14	18	23	27	32	36
10	5	10	15	20	25	30	35	40
15	8	15	23	30	38	45	53	60

2.3. Pipe support distances

Consistent fastening of plastic pipes depends mainly on the longitudinal expansion of the material. The mutual distance of the pipe supports depends on the operating conditions, the material of the pipe, the weight of the pipe and the weight of the transported medium. The total length of the pipe must be divided into individual parts - expansion sections, in which expansion or contraction is allowed. Expansion joints delimit fixed points PB. Between the fixed points, the pipe is mounted on sliding points KU. Support distances for individual types of pipes are in the following charts.

Maximum support distance of all-plastic pipes FV PP-RCT UNI for horizontal pipes

Pipe diameter [mm]	Support distance [cm] at water temperature		
	20 °C	30 °C	40 °C
16	75	70	70
20	80	75	70
25	85	85	85
32	100	95	95
40	110	110	105
50	125	120	115
63	140	135	130
75	155	150	145
90	165	165	155
110	185	180	175
125	200	195	185

Maximum support distance of all-plastic pipes FV PPR CLASSIC S3.2 SDR7.4 (PN 16) and FV PP-RCT HOT S3.2 SDR7.4 for horizontal pipes.

Pipe diameter [mm]	Support distance [cm] at water temperature					
	20 °C	30 °C	40 °C	50 °C	60 °C	80 °C
16	80	75	75	70	70	60
20	90	80	80	80	70	65
25	95	95	95	90	80	75
32	110	105	105	100	95	80
40	120	120	115	105	100	95
50	135	130	125	120	115	100
63	155	150	145	135	130	115
75	170	165	160	150	145	125
90	180	180	170	165	160	135
110	200	195	190	180	175	155
125	220	215	200	195	190	165

Maximum support distance of pipes FV PPR CLASSIC S2,5 SDR6 (PN20) for horizontal pipes

Pipe diameter [mm]	Support distance [cm] at water temperature					
	20 °C	30 °C	40 °C	50 °C	60 °C	80 °C
16	90	85	85	80	80	65
20	95	90	85	85	80	70
25	100	100	100	95	90	85
32	120	115	115	110	100	90
40	130	130	125	120	115	100
50	150	150	140	130	125	110
63	170	160	155	150	145	125
75	185	180	175	160	155	140
90	200	200	185	180	175	150
110	210	215	210	195	190	165
125	235	230	225	210	200	170

Maximum support distance of multilayer pipes FV PP-RCT FASER COOL for horizontal pipes

Pipe diameter [mm]	Support distance [cm] at water temperature						
	20 °C	30 °C	40 °C	50 °C	60 °C	70 °C	80 °C
40	120	115	110	105	100	95	90
50	140	135	130	125	120	115	110
63	150	145	140	135	130	125	120
75	165	160	155	150	145	140	130
90	175	170	165	160	155	150	135
110	185	180	175	165	160	155	145
125	205	195	190	180	170	160	150
160	205	195	185	180	170	160	150
200	230	220	210	205	195	185	175
250	260	250	240	230	220	210	195



Maximum support distance of multilayer pipes FV PP-RCT FASER HOT for horizontal pipes

Pipe diameter [mm]	Support distance [cm] at water temperature						
	20 °C	30 °C	40 °C	50 °C	60 °C	70 °C	80 °C
20	100	90	85	85	80	70	65
25	105	100	95	90	85	80	75
32	120	115	110	105	100	95	90
40	130	125	120	115	110	105	100
50	150	145	140	135	130	125	120
63	160	155	150	145	140	135	130
75	180	175	170	165	160	155	145
90	190	185	180	175	170	165	150
110	200	195	190	180	175	170	160
125	220	210	205	195	185	175	165
160	220	210	205	195	185	175	165
200	245	235	225	220	210	200	190
250	275	265	255	245	235	225	210

KU in the place of fitting the pipe

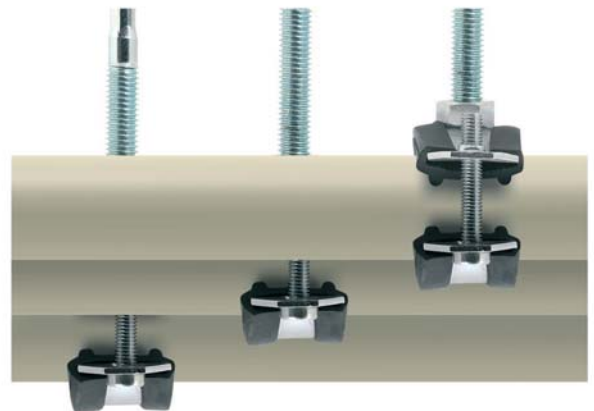

For vertical pipes of all types of pipes, the maximum support distances are multiplied by a coefficient of 1,3.

2.4. Pipe fixing

For leading the pipeline route, it is necessary to respect the distribution material, ie. especially longitudinal thermal expansion, the need for compensations, given operating conditions (combination of pressure and temperature) and the method of joining.

The distribution mounting is done in such a way that the fixed points (PB) and sliding points (KU) are distinguished for the expected length change of the pipeline.

PB with tightly clamped sleeves (only for horizontal pipes)



PB by mounting on the fitting

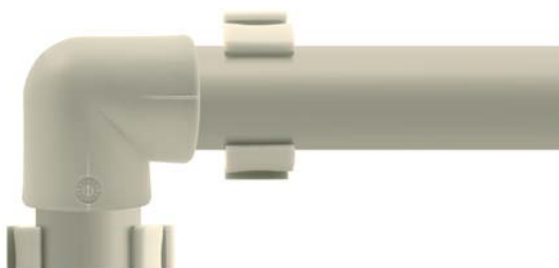

KU in pipe bend

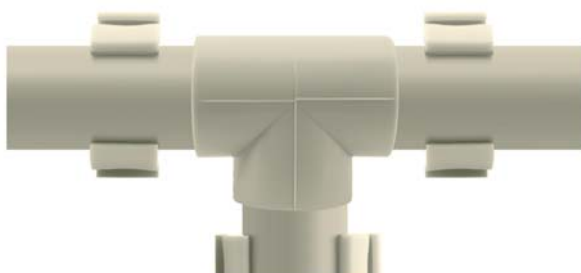

KU at the turn



KU free sleeve

Use of plastic sleeves on cold water



Suitable for cold water distribution

Use of plastic sleeves on cold water



For hot water, the sleeve is installed over a larger insulation

Other ways of laying plastic pipes

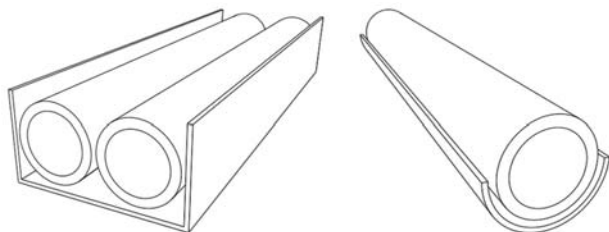

By laying the pipes in a free drain

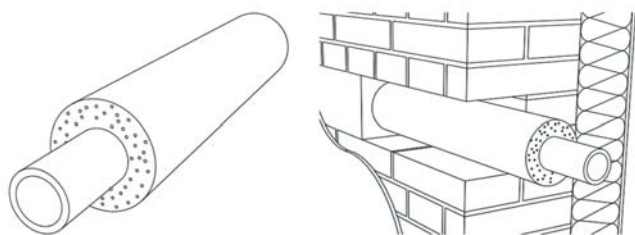

Piping in insulation under plaster

Pipe leading

The piping must be installed with a slope of at least 0.5% to the lowest places where it can be drained by a separate drain or shut-off valves with drainage.

The piping must be divided into separately closable parts. Direct valves or plastic taps are used for closing, under plaster valves or taps are used for flush-mounted installation. Before mounting the element, it is necessary to test the closing ability.

To terminate the pipe under the plaster at the installation site of the mixing outlet fitting, it is recommended to use a FV PPR wall set (double plate), where the pitch of the threads is shifted so that any deviation from the horizontal axis can be leveled.

A novelty are FV PPR elbows with a metal UNI internal thread, which together with the DUO or MONO washer form a variant of wall elbows and a double wall elbow with an adjustable spacing. For installation under plasterboard, FV PPR wall elbows for plasterboard are intended.

When routing water pipes in installation partitions, it is necessary to secure the position of the pipes with a suitable fastening, eg a system of metal sleeves with support elements. The piping must be laid with the possibility of expansion and insulated.

When laying water pipes in floor or ceiling structures, flexible plastic protectors (made of polyethylene) are used on the pipes, which ensure mechanical protection of the pipes and at the same time the air gap between the pipes and the protector creates thermal insulation. Loose plastic pipes must be provided with good insulation (for example, if the cold water pipe is laid freely along the wall in a heated room, there is a high risk of moisture condensation on the pipe wall). The pipeline can be run freely along the wall only in areas where there is no risk of mechanical damage to the pipeline during operation.

2.5. Riser piping

Care must be taken in the riser on the location of fixed points (PB), sliding points (KU) and on the creation of a suitable compensation method. Compensation is provided on the risers either by sliding on the base of the riser or by using a compensation loop.

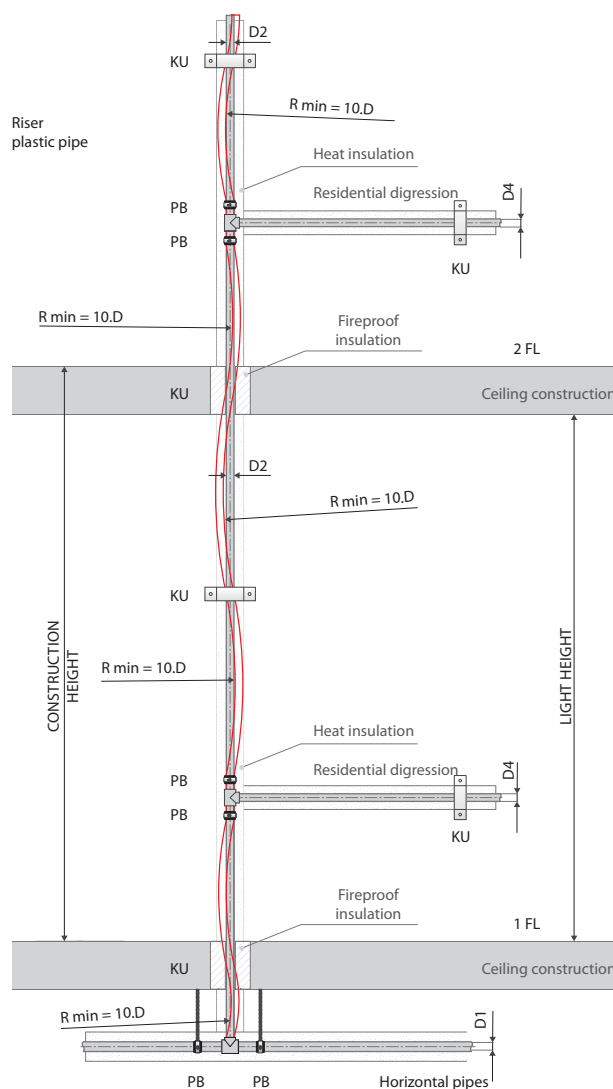

EXPLANATIONS:

- Pipes before heating
- Pipes after heating

- PB Fixed point
- KU Sliding point
- D Outer pipe diameter [mm]
- R min Minimum bending radius

ASSEMBLY INSTRUCTION

If it is necessary to divide the riser into several expansion sections, this is done by placing fixed points. A fixed point on the riser is installed below and above the T-piece at the digression or at the socket at the pipe connection, thus preventing the riser from falling. Pipe expansion must then be allowed between the fixed points.

When branching the connecting pipe, the expansion of the riser must be taken into account:

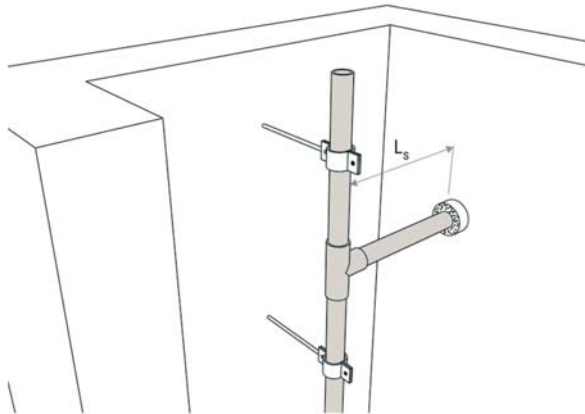

Sufficient distance of the riser from the passage through the wall

FASER pipes have 3x lower expansion and greater rigidity than all-plastic pipes. The pipes can therefore be mounted on the same principle described above as all-plastic pipes, ie with the classic procedure of solving compensations, when the possible larger distances of supports will be used and the expansion and compensation lengths will be significantly smaller. When leading in a groove, so-called rigid mounting can also be used - fixed points are mounted on the pipe so that the thermal expansion is transferred to the pipe material and does not manifest itself. The assumption for this installation are sleeves that will be able to actually hold the pipe and will be anchored sufficiently firmly.

2.6. Connecting to the system

The piping system can be connected by welding or mechanical joints.

The connection of the pipe with the fitting is performed identically for all types of pipes, the fittings are identical.

Pipes and fittings are connected by polyfusion welding, larger diameters using an electric fitting or by butt welding. All methods must be performed exactly according to approved work procedures.

Pipe division

The pipes can only be divided (cut) with sharp, well-sharpened tools. It is recommended to use special scissors or a cutter for plastic pipes.



Adapters with pressed brass nickel-plated internal and external threads are generally used for the transition of plastics in hot water and heating pipes.

Tightening wrenches with tape are used to tighten screwed connections with pressed threads, unless the adapter is provided with a polygon directly on the metal part.

Warning:

The use of adapters with plastic threads is not permissible in sanitary engineering for thermal engineering and physical - mechanical reasons. Adapters with plastic threads can be used, for example, when setting up temporary wiring.

Joint seals

Sealing of screwed joints is done exclusively with Teflon tape, Teflon thread or a special sealing mastic.

FV MULTI PIPES

FV MULTIPERT-AL pipe in coil

System: **AQUA**
 Material: PE-RT/AL/PE-RT
 Standard: ČSN EN ISO 21003, DIN 4726

Note: Five-layer, polyethylene pipe PE-RT II with an longitudinally welded aluminium layer. Increased heat resistance (acc. to EN ISO 22391). Oxygen barrier of aluminium according to DIN 4726. Tmax 95°C.

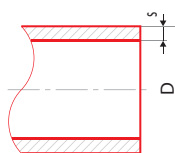

Objekt	Průměr	Průměr	Průměr	Průměr	hm	#	D [mm]	s [mm]	l [m]	
16 × 2,0	m	200			0,105	0,20	AA130016200	16	2,00	200
18 × 2,0	m	200			0,123	0,25	AA130018200	18	2,00	200
20 × 2,0	m	200			0,148	0,31	AA130020200	20	2,00	200
20 × 2,0	m	100			0,148	0,31	AA130020100	20	2,00	100
25 × 2,5	m	50			0,228	0,49	AA130025050	25	2,50	50
26 × 3,0	m	50			0,262	0,53	AA130026050	26	3,00	50
32 × 3,0	m	50			0,344	0,80	AA130032050	32	3,00	50

FV MULTIPERT-AL pipe in bars

System: **AQUA**
 Material: PE-RT/AL/PE-RT
 Standard: ČSN EN ISO 21003, DIN 4726

Note: 5-layer polyethylene pipe PE-RT II with one layer made from aluminium, increased heat resistance (according to EN ISO 22391), with oxygen barrier from aluminium according to DIN 4726, Tmax 95°C.

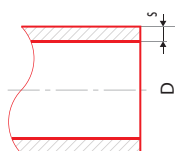

Objekt	Průměr	Průměr	Průměr	Průměr	hm	#	D [mm]	s [mm]	l [m]	
16 × 2,0	m	160			0,105	0,20	AA130016004	16	2,00	4
18 × 2,0	m	120			0,123	0,25	AA130018004	18	2,00	4
20 × 2,0	m	100			0,148	0,31	AA130020004	20	2,00	4
26 × 3,0	m	60			0,262	0,534	AA130026004	26	3,00	4
32 × 3,0	m	40			0,344	0,80	AA130032004	32	3,00	4

FV MULTIPERT-AL pre-insulated pipe 6 mm in coil

System: **AQUA**
 Materiál: PE-RT/AL/PE-RT
 Standard: ČSN EN ISO 21003, DIN 4726

Poznámka: Pre-insulated pipes are made of PE-RT/Al/PE-RT material for cold and hot water distribution and heating in the most demanding conditions. Top notch 6 mm insulation.

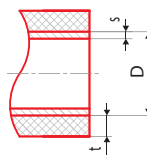

Objekt	Průměr	Průměr	Průměr	Průměr	hm	#	#	D [mm]	s [mm]	t [mm]	l [m]	
16 × 2,0 × 6	m	50			0,142	2,176	AA138016050	AA138116050	16	2,0	6	50
20 × 2,0 × 6	m	50			0,204	2,176	AA138020050	AA138120050	20	2,0	6	50

FV MULTIPERT-AL pre-insulated pipe 10 mm in coil

System: **AQUA**
 Materiál: PE-RT/AL/PE-RT
 Standard: ČSN EN ISO 21003, DIN 4726

Poznámka: Pre-insulated pipes are made of PE-RT/Al/PE-RT material for cold and hot water distribution and heating in the most demanding conditions. Top notch 10 mm insulation.

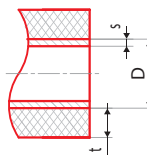

Objekt	Průměr	Průměr	Průměr	Průměr	hm	#	#	D [mm]	s [mm]	t [mm]	l [m]	
16 × 2,0 × 10	m	50			0,152	2,176	AA138016051	AA138116051	16	2,0	10	50
20 × 2,0 × 10	m	50			0,204	2,176	AA138020051	AA138120051	20	2,0	10	50
26 × 3,0 × 10	m	200			0,286	2,176	AA138026251	AA138126051	26	3,0	10	50
32 × 3,0 × 10	m	100			0,658	2,176	AA138032026	AA138132051	32	3,0	10	25

FV M-PRESS BRASS PRESS FITTINGS

FV M-PRESS reducer with cap nut

System: **AQUA**
 Material: Brass
 Standard: -

Note: Transition fitting from MULTI part to metal part of pipeline.

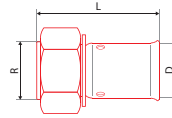

QTY	UNIT	PKT	PKT	PKT	dm³	#	D [mm]	L [mm]	R
16 x 2,0-3/8"	pcs		10			AA300016038	16	54	3/8"
16 x 2,0-1/2"	pcs		10			AA300016012	16	56	1/2"
16 x 2,0-3/4"	pcs		10			AA300016034	16	56	3/4"
20 x 2,0-1/2"	pcs		10			AA300020012	20	57	1/2"
20 x 2,0-3/4"	pcs		10			AA300020034	20	56	3/4"
26 x 3,0-3/4"	pcs		5			AA300026034	26	60	3/4"
26 x 3,0-1"	pcs		5			AA300026010	26	58	1"
32 x 3,0-1"	pcs		2			AA300032010	32	63	1"
32 x 3,0-1 1/4"	pcs		2			AA300032054	32	57	1 1/4"

FV M-PRESS reducing sleeve with metal female thread

System: **AQUA**
 Material: Brass
 Standard: -

Note: Transition fitting from MULTI part to metal part of pipeline.

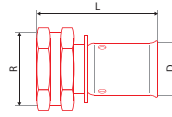

QTY	UNIT	PKT	PKT	PKT	dm³	#	D [mm]	L [mm]	R
16 x 2,0-1/2"	pcs		10			AA301016012	16	54	1/2"
16 x 2,0-3/4"	pcs		10			AA301016034	16	56	3/4"
18 x 2,0-1/2"	pcs		10			AA301018012	18	54	1/2"
18 x 2,0-3/4"	pcs		10			AA301018034	18	56	3/4"
20 x 2,0-1/2"	pcs		10			AA301020012	20	54	1/2"
20 x 2,0-3/4"	pcs		10			AA301020034	20	56	3/4"
20 x 2,0-1"	pcs		5			AA301020010	20	63	1"
26 x 3,0-3/4"	pcs		5			AA301026034	26	53	3/4"
26 x 3,0-1"	pcs		5			AA301026010	26	63	1"
32 x 3,0-1"	pcs		5			AA301032010	32	55	1"
32 x 3,0-1 1/4"	pcs		5			AA301032054	32	64	1 1/4"

FV M-PRESS reducing sleeve with metal male thread

System: **AQUA**
 Material: Brass
 Standard: -

Note: Transition fitting from MULTI part to metal part of pipeline.

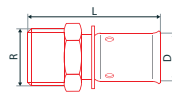

QTY	UNIT	PKT	PKT	PKT	dm³	#	D [mm]	L [mm]	R
16 x 2,0-3/8"	pcs		10			AA302016038	16	52	3/8"
16 x 2,0-1/2"	pcs		10			AA302016012	16	57	1/2"
16 x 2,0-3/4"	pcs		10			AA302016034	16	55	3/4"
18 x 2,0-1/2"	pcs		10			AA302018012	18	57	1/2"
18 x 2,0-3/4"	pcs		10			AA302018034	18	55	3/4"
20 x 2,0-1/2"	pcs		10			AA302020012	20	57	1/2"
20 x 2,0-3/4"	pcs		10			AA302020034	20	57	3/4"
26 x 3,0-1/2"	pcs		10			AA302026012	26	59	1/2"
26 x 3,0-3/4"	pcs		5			AA302026034	26	59	3/4"
26 x 3,0-1"	pcs		5			AA302026010	26	62	1"
32 x 3,0-1"	pcs		5			AA302032010	32	64	1"

FV M-PRESS join

System: **AQUA**
 Material: Brass
 Standard: -

Note: A simple, reliable fitting for pipe connection.

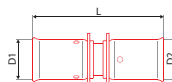

Image	Unit	Grid	Grid	Icon	dm³	#	D [mm]	L [mm]	D2 [mm]
	pcs		10			AA305016000	16	66	16
	pcs		10			AA305018000	18	66	18
	pcs		10			AA305020000	20	66	20
	pcs		10			AA305026000	26	66	26
	pcs		5			AA305032000	32	68	32

FV M-PRESS reduction

System: **AQUA**
 Material: Brass
 Standard: -

Note: A simple, reliable fitting for pipe dimension reduction.

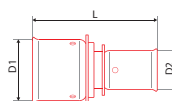

Image	Unit	Grid	Grid	Icon	dm³	#	D1 [mm]	L [mm]	D2 [mm]
	pcs		10			AA306018016	18	66	16
	pcs		10			AA306020016	20	66	16
	pcs		10			AA306020018	20	66	18
	pcs		10			AA306026016	26	66	16
	pcs		10			AA306026018	26	66	18
	pcs		10			AA306026020	26	66	20
	pcs		5			AA306032016	32	68	16
	pcs		5			AA306032020	32	68	20
	pcs		5			AA306032026	32	68	26

FV M-PRESS elbow 90°

System: **AQUA**
 Material: Brass
 Standard: -

Note: A simple, reliable fitting for changing the pipeline direction.

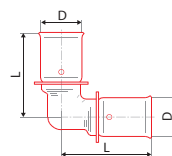

Image	Unit	Grid	Grid	Icon	dm³	#	D [mm]	L [mm]	L [mm]
	pcs		10			AA309016000	16	47	47
	pcs		10			AA309018000	18	50	50
	pcs		5			AA309020000	20	50	50
	pcs		5			AA309026000	26	52	52
	pcs		5			AA309032000	32	55	55

Press fittings in all-metal design for pipes Ø 16 to Ø 32 - a reliable connection is created using press pliers (TH system), which press the stainless steel ring on the pipe body and the brass part of the fitting. The connection is further inseparable.



FV M-PRESS elbow 45°

System: **AQUA**
 Material: Brass
 Standard: -

Note: A simple, reliable fitting for changing the pipeline direction.

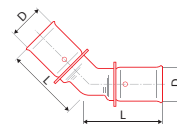

QTY	UNIT	PKT	PKT	PKT	dm³	#	D [mm]	L [mm]	L [mm]
16 x 2,0	pcs		10			AA304516000	16	47	47
18 x 2,0	pcs		10			AA304518000	18	50	50
20 x 2,0	pcs		5			AA304520000	20	50	50
26 x 3,0	pcs		5			AA304526000	26	52	52
32 x 3,0	pcs		5			AA304532000	32	50	50

FV M-PRESS elbow 90° for wall mounting

System: **AQUA**
 Material: Brass
 Standard: -

Note: Fixing fitting with tap connector for mixers.

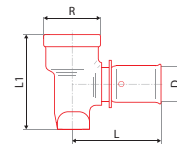

QTY	UNIT	PKT	PKT	PKT	dm³	#	D [mm]	L [mm]	L1 [mm]
16 x 2,0-1/2"	pcs		5			AA310016012	16	53	53
18 x 2,0-1/2"	pcs		5			AA310018012	18	53	53
20 x 2,0-1/2"	pcs		5			AA310020012	20	53	53
20 x 2,0-3/4"	pcs		5			AA310020034	20	53	53

FV M-PRESS running elbow 90° for wall mounting

System: **AQUA**
 Material: Brass
 Standard: -

Note: Fixing fitting with tap connector for mixers.

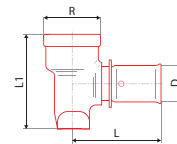

QTY	UNIT	PKT	PKT	PKT	dm³	#	D [mm]	L [mm]	L1 [mm]
16 x 2,0-1/2"	pcs		5			AA310116012	16	53	53
18 x 2,0-1/2"	pcs		10			AA310118012	18	53	53
20 x 2,0-1/2"	pcs		5			AA310120012	20	53	53

FV M-PRESS running elbow 180° for wall mounting

System: **AQUA**
 Material: Brass
 Standard: -

Note: Fixing fitting with tap connector for mixers.

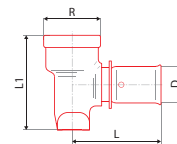

QTY	UNIT	PKT	PKT	PKT	dm³	#	D [mm]	L [mm]	L1 [mm]
16 x 2,0-1/2"	pcs		5			AA310216012	16	80	40
18 x 2,0-1/2"	pcs		5			AA310218012	18	80	40
20 x 2,0-1/2"	pcs		5			AA310220012	20	80	40

FV M-PRESS elbow 90° with metal female thread

System: **AQUA**
Material: Brass
Standard: -

Note: Transition fitting from MULTI part to metal part of pipeline.

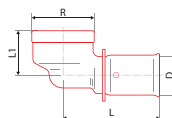

DN	Unit	Quantity	Weight [kg]	Volume [dm ³]	#	D [mm]	L [mm]	L1 [mm]
16 x 2,0-1/2"	pcs	10			AA312016012	16	49	34
18 x 2,0-1/2"	pcs	10			AA312018012	18	50	34
20 x 2,0-1/2"	pcs	10			AA312020012	20	50	34
20 x 2,0-3/4"	pcs	10			AA312020034	20	50	35
26 x 3,0-3/4"	pcs	5			AA312026034	26	52	40
26 x 3,0-1"	pcs	5			AA312026010	26	55	40
32 x 3,0-1"	pcs	5			AA312032010	32	55	46

FV M-PRESS elbow 90° with metal male thread

System: **AQUA**
Material: Brass
Standard: -

Note: Transition fitting from MULTI part to metal part of pipeline.

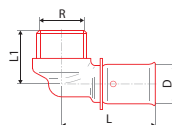

DN	Unit	Quantity	Weight [kg]	Volume [dm ³]	#	D [mm]	L [mm]	L1 [mm]
16 x 2,0-3/8"	pcs	10			AA313016038	16	49	30
16 x 2,0-1/2"	pcs	10			AA313016012	16	49	35
18 x 2,0-1/2"	pcs	10			AA313018012	18	50	35
20 x 2,0-1/2"	pcs	10			AA313020012	20	50	35
20 x 2,0-3/4"	pcs	10			AA313020034	20	50	35
26 x 3,0-3/4"	pcs	5			AA313026034	26	52	43
26 x 3,0-1"	pcs	5			AA313026010	26	52	41
32 x 3,0-1"	pcs	5			AA313032010	32	55	46

FV M-PRESS elbow 90° reducing sleeve with cap nut

System: **AQUA**
Material: Brass
Standard: -

Note: Transition fitting from MULTI part to metal part of pipeline.

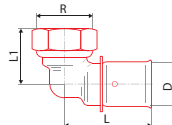

DN	Unit	Quantity	Weight [kg]	Volume [dm ³]	#	D [mm]	L [mm]	L1 [mm]
16 x 2,0-1/2"	pcs	10			AA314016012	16	49	35
16 x 2,0-3/4"	pcs	10			AA314016034	16	49	35
20 x 2,0-1/2"	pcs	10			AA314020012	20	50	35
20 x 2,0-3/4"	pcs	10			AA314020034	20	50	35
26 x 3,0-3/4"	pcs	5			AA314026034	26	52	38
26 x 3,0-1"	pcs	5			AA314026010	26	52	38
32 x 3,0-1"	pcs	5			AA314032010	32	55	41
32 x 3,0-1 1/4"	pcs	5			AA314032054	32	55	43

FV M-PRESS wall mounting group with tap connectors for gypsum walls

System: **AQUA**
Material: Brass
Standard: -

Note: Fixing fitting with tap connector for mixers, for gypsum walls.

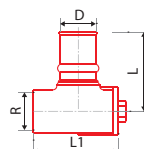

DN	Unit	Quantity	Weight [kg]	Volume [dm ³]	#	D [mm]	L [mm]	L1 [mm]
16 x 2,0-1/2"	pcs	1			AA315016012	16	48	51,5
20 x 2,0-1/2"	pcs	1			AA315020012	20	48	51,5

FV M-PRESS wall mounting group with tap connectors

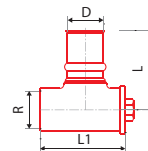

System: **AQUA**

Material: Brass

Standard: -

Note: Tap water connectors with adjustable distance.

							D [mm]	L [mm]	L1 [mm]
16 x 2,0-1/2"	pcs		1			AA316016012	16	48	51,5
20 x 2,0-1/2"	pcs		1			AA316020012	20	48	51,5

FV M-PRESS tee

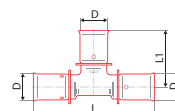

System: **AQUA**

Material: Brass

Standard: -

Note: A simple, reliable fitting for branching the pipeline.

							D [mm]	L [mm]	L1 [mm]
16 x 2,0	pcs		10			AA317016000	16	93	47
18 x 2,0	pcs		10			AA317018000	18	100	50
20 x 2,0	pcs		5			AA317020000	20	100	50
26 x 3,0	pcs		2			AA317026000	26	104	52
32 x 3,0	pcs		5			AA317032000	32	110	55

FV M-PRESS tee reduced

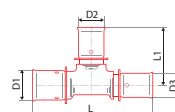

System: **AQUA**

Material: Brass

Standard: -

Note: A simple, reliable fitting for branching the pipeline.

							D1 [mm]	D2 [mm]	D3 [mm]	L [mm]	L1 [mm]
16-20-16	pcs		5			AA318162016	16	20	16	100	50
18-16-16	pcs		10			AA318181616	18	16	16	100	50
18-16-18	pcs		10			AA318181618	18	16	18	100	50
18-18-16	pcs		10			AA318181816	18	18	16	100	50
20-16-16	pcs		10			AA318201616	20	16	16	100	50
20-16-20	pcs		5			AA318201620	20	16	20	100	50
20-18-18	pcs		5			AA318201818	20	18	18	100	50
20-18-20	pcs		5			AA318201820	20	18	20	100	50
20-20-16	pcs		5			AA318202016	20	20	16	100	50
20-26-20	pcs		5			AA318202620	20	26	20	106	53
26-16-16	pcs		5			AA318261616	26	16	16	105	53
26-16-20	pcs		5			AA318261620	26	16	20	105	53
26-16-26	pcs		5			AA318261626	26	16	26	104	53
26-18-26	pcs		5			AA318261826	26	18	26	104	52
26-20-16	pcs		5			AA318262016	26	20	16	105	53
26-20-20	pcs		5			AA318262020	26	20	20	104	52
26-20-26	pcs		5			AA318262026	26	20	26	104	52
26-26-16	pcs		5			AA318262616	26	26	16	104	52
26-26-20	pcs		5			AA318262620	26	26	20	104	52
26-32-26	pcs		2			AA318263226	26	32	26	112	55
32-20-20	pcs		2			AA318322020	32	20	20	110	55
32-20-26	pcs		5			AA318322026	32	20	26	110	55
32-16-32	pcs		2			AA318321632	32	16	32	110	55
32-18-32	pcs		2			AA318321832	32	18	32	110	55
32-20-32	pcs		2			AA318322032	32	20	32	110	55
32-26-26	pcs		2			AA318322626	32	26	26	110	55
32-26-32	pcs		2			AA318322632	32	26	32	110	55

FV M-PRESS tee with metal female thread

System: **AQUA**
Material: Brass
Standard: -

Note: Transition fitting from FV MULTI part to metal part of pipeline.

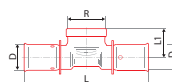

Icon	Symbol	Grid	Grid	Grid	dm ³	#	D [mm]	L [mm]	L1 [mm]
	pcs		5			AA319016012	16	97	34
	pcs		5			AA319018012	18	100	34
	pcs		5			AA319018034	18	100	35
	pcs		5			AA319020012	20	100	34
	pcs		5			AA319020034	20	100	35
	pcs		5			AA319026012	26	104	40
	pcs		5			AA319026034	26	104	40
	pcs		2			AA319032012	32	110	45
	pcs		2			AA319032034	32	110	46
	pcs		2			AA319032010	32	110	46

FV M-PRESS tee with metal male thread

System: **AQUA**
Material: Brass
Standard: -

Note: Transition fitting from FV MULTI part to metal part of pipeline.

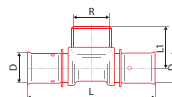

Icon	Symbol	Grid	Grid	Grid	dm ³	#	D [mm]	L [mm]	L1 [mm]
	pcs		5			AA320016012	16	97	35
	pcs		5			AA320016034	16	97	35
	pcs		5			AA320018012	18	100	35
	pcs		5			AA320018034	18	100	35
	pcs		5			AA320020012	20	100	35
	pcs		5			AA320020034	20	100	35
	pcs		5			AA320026034	26	104	43
	pcs		2			AA320032010	32	110	46

FV M-PRESS shut off ball valve lux straight with chrome handle

System: **AQUA**
Material: Brass
Standard: -

Note: An elegant above-plaster ball valve for closing branches of a distribution system.

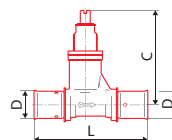

Icon	Symbol	Grid	Grid	Grid	dm ³	#	L [mm]	Cmin-Cmax [mm]	Emax [mm]
	pcs		4			AA321016000	148	23-38	86
	pcs		4			AA321018000	148	23-38	86
	pcs		4			AA321020000	148	23-38	86
	pcs		4			AA321026000	154	26-41	89

FV M-PRESS shut off ball valve straight with cover

System: **AQUA**
Material: Brass
Standard: -

Note: An elegant above-plaster ball valve for closing branches of a distribution system.

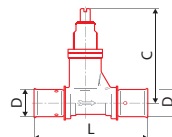

Icon	Symbol	Grid	Grid	Grid	dm ³	#	L [mm]	Cmin-Cmax [mm]	Emin-Emax [mm]
	pcs		4			AA323016000	148	36-51	83-96
	pcs		4			AA323018000	148	36-51	83-96
	pcs		4			AA323020000	148	36-51	83-96
	pcs		4			AA323026000	154	39-54	86-99

FV M-PRESS joining elbow 90° to the radiator

System: **AQUA**
 Material: Brass
 Standard: -
 Note: For radiator connection.

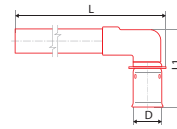

QTY	UNIT	PKT	PKT	PKT	PKT	#	D [mm]	L [mm]
16 x 2,0-Cu 15	pcs		2			AA324016015	15	300
20 x 2,0-Cu 15	pcs		2			AA324020015	15	300

FV M-PRESS reducing sleeve to CU

System: **AQUA**
 Material: Brass
 Standard: -
 Note: Transition fitting from FV MULTI part to cooper part of pipeline.

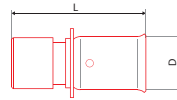

QTY	UNIT	PKT	PKT	PKT	PKT	#	D [mm]	L [mm]
16 x 2,0-Cu 14	pcs		10			AA326016014	16	62
16 x 2,0-Cu 15	pcs		10			AA326016015	16	62
16 x 2,0-Cu 16	pcs		10			AA326016016	16	62
20 x 2,0-Cu 18	pcs		10			AA326020018	20	63
25 x 2,0-Cu 22	pcs		10			AA326025022	25	60

FV M-PRESS blinding

System: **AQUA**
 Material: Brass
 Standard: -
 Note: For permanent or temporary blind of CU pipe.

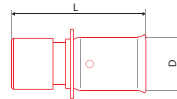

QTY	UNIT	PKT	PKT	PKT	PKT	#	D [mm]	L [mm]
16 x 2,0	pcs		10			AA327016000	16	35
18 x 2,0	pcs		10			AA327018000	18	35
20 x 2,0	pcs		10			AA327020000	20	35
26 x 3,0	pcs		10			AA327026000	26	35
32 x 3,0	pcs		10			AA327032000	32	36

TOOLS FOR FV MULTI

Calibrator MULTI

System: **AQUA**

Material: -

Standard: -

Note: Robust metal calibrator for the most common diameters of multilayer pipes 16, 20, 25, 32.



						#			
Ø 16-20-25-32	pcs	1	1			AA42900000			

Bending pipe spring outer for FV MULTI pipes

System: **AQUA**

Material: -

Standard: -

Note: Bending spring ensures a perfect fold multilayer pipes without the risk of pipe breakage.



						#			
16 x 2,0	pcs	1	1			AA430016000			
18 x 2,0	pcs	1	1			AA430018000			
20 x 2,0	pcs	1	1			AA430020000			
26 x 3,0	pcs	1	1			AA430026000			

Bending pipe spring inner for FV MULTI pipes

System: **AQUA**

Material: -

Standard: -

Note: Bending spring ensures a perfect fold multilayer pipes without the risk of pipe breakage.



						#			
16 x 2,0	pcs	1	1			AA430016001			
18 x 2,0	pcs	1	1			AA430018001			
20 x 2,0	pcs	1	1			AA430020001			
26 x 3,0	pcs	1	1			AA430026001			

ASSEMBLY INSTRUCTIONS FOR FV AQUA CONNECTION WITH PRESS FITTINGS

Characteristics

FV M-PRESS fittings are designed for creating water distribution and heating from multilayer pipes FV MULTIPERT-5 and FV MULTIPERT-AL.

FV M-PRESS

- A complete range of top brass press fittings for a wide range of applications, even in the most demanding applications such as heating water distribution
- Wide range from diameter from D16 to D63 (according to fitting type)
- Adapters with external or internal thread, eurocone, coupling nut and adapters for copper distribution lines connected by pressing or soldering guarantee easy connection to any other distribution systems
- Various types of elbows, digressions, unambiguous T-pieces as well with reduction and elbows for connecting the radiator form a complete system for easy implementation of heating distribution
- Various wall elbows and continuous wall panels with threaded connections for easy connection of water distribution systems to fixtures



CONNECTION WITH FV M-PRESS FITTINGS

FV M-PRESS fittings are in principle based on the perfect sealing of the press-fit connection by means of specially shaped grooves, rubber O-rings and a positioning bearing of the cuff.

Picture no.1: The stainless steel cuff no. 1 is mounted in a positioning bearing no. 2, which adapts to the shape of the pressing jaw during pressing and its connection with the fitting remains resistant to moisture penetration (from plaster or condensate). The two O-ring seals no.3 ensure a perfect sealing of the inner space of the fit-

ting against pressurized water. The inner space of the fitting is thus protected from moisture, which can successfully prevent possible corrosion of the Al layer on the cut of multilayer pipes.

Perfect pressing of the joint no.4 is guaranteed by the Autolock system, which prevents the jaws of the pressing attachments from moving away before the pressing is completed. The fittings of the FV M-PRESS series meet the strictest requirements for ensuring tightness and health safety according to the requirements of the certification authorities SKZ and DVGW.

Picture no.1:

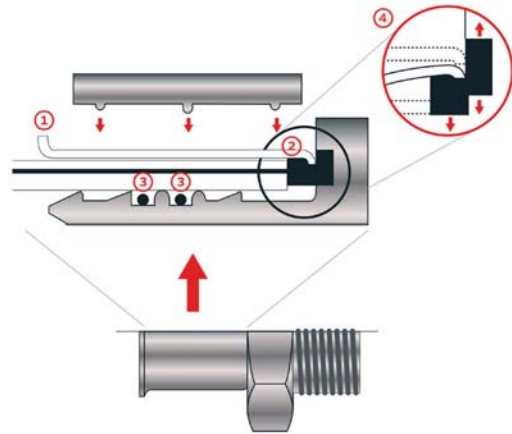

Standard press jaws of the following types are used for pressing FV M-PRESS fittings:

16 x 2,0	=	U, H, TH and RF
18 x 2,0	=	U and H
20 x 2,0	=	U, H, TH and RF
25 x 2,5	=	U, H, TH and RF
26 x 3,0	=	U, H, TH and RF
32 x 3,0	=	U, H, TH and RF
40 x 3,5	=	U
50 x 4,0	=	U
63 x 4,5	=	U

ACCESSORIES

Pipe insulation Tubex (foamed PE)

System: **AQUA**
 Material: PE
 Standard: -

Note: Excellent supplement for thermal and acoustic insulation of water distribution and heating. Made of polyethylene foam with soft structure of closed cells. Significantly reduce thermal losses, prevents condensation on distribution of cold water and cooling devices, muffle sound.



Ø x H	⊕	⊞	⊠	⊡	⊣	dm ³	#			
18 x 6	m	520	2	0,01	0,92	AA970018006				
18 x 10	m	320	2	0,02	1,50	AA970018010				
22 x 6	m	400	2	0,02	1,20	AA970022006				
22 x 10	m	270	2	0,04	1,78	AA970022010				
28 x 6	m	280	2	0,02	1,71	AA970028006				
28 x 10	m	190	2	0,04	2,53	AA970028010				
35 x 6	m	210	2	0,03	2,29	AA970035006				
35 x 10	m	150	2	0,04	3,20	AA970035010				
42 x 10	m	120	2	0,04	4,00	AA970042010				
42 x 15	m	80	2	0,07	6,00	AA970042015				
52 x 10	m	80	2	0,07	6,00	AA970052010				
52 x 15	m	70	2	0,10	6,86	AA970052015				
65 x 10	m	66	2	0,08	7,27	AA970065010				
65 x 15	m	54	2	0,11	8,89	AA970065015				
76 x 10	m	50	2	0,11	9,60	AA970076010				
76 x 15	m	38	2	0,11	12,63	AA970076015				
92 x 15	m	28	2	0,14	17,14	AA970092015				
92 x 20	m	24	2	0,20	20,00	AA970092020				
114 x 15	m	20	2	0,56	24,00	AA970114015				

Adhesive tape

System: **AQUA**
 Material: -
 Standard: -

Note: Double - adhesive tape for attaching insulation on the pipe.



Ø x H	⊕	⊞	⊠	⊡	⊣	dm ³	#			
40 mm x 25 m	pcs	1	1	0,214	2,12	AA971000000				

Insulation adhesive tape

System: **AQUA**
 Material: -
 Standard: -

Note: Special tape for pasting the cut insulation.



Ø x H	⊕	⊞	⊠	⊡	⊣	dm ³	#			
40 mm x 20 m	pcs	1	1	0,142	0,176	AA972000020				

Insulation clip

System: **AQUA**
 Material: PP-R
 Standard: -

Note: Special clip for providing insulation of distribution without spaces.



Icon	⊕	⊞	⊠	⊡	⊣	dm ³	#
	pcs	10000	100	0,01	0,01		AA973000000

Insulation felt

System: **AQUA**
 Material: -
 Standard: -

Note: For thermal insulation of pipes in spaces, where can not be used Tubex insulation.



Icon	⊕	⊞	⊠	⊡	⊣	dm ³	#
70 mm x 10 m	pcs	50	1	0,16	3,1		AA974000000

O-ring Taboren

System: **AQUA**
 Material: PE
 Standard: -

Note: Special seal for sealing fittings with union nut.



Icon	⊕	⊞	⊠	⊡	⊣	dm ³	#
1/2"	pcs	6000	200	0,01	0,01		AA975000012
3/4"	pcs	3000	300	0,01	0,01		AA975000034
1"	pcs	2000	300	0,01	0,01		AA975000001
5/4"	pcs	1400	300	0,01	0,01		AA975000054
6/4"	pcs	1000	300	0,01	0,01		AA975000064
2"	pcs	600	300	0,01	0,01		AA975000002

Teflon insulation tape

System: **AQUA**
 Material: teflon
 Standard: -

Note: Tape for sealing of fittings with metal thread.



Icon	⊕	⊞	⊠	⊡	⊣	dm ³	#
10 m	pcs	300	10	0,01	0,06		AA975001010

Plastic clip PP

System: **AQUA**
Material: PP-R
Standard: -

Note: Plastic clip for sliding point of pipe on the wall.

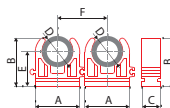

Code	Quantity	Area [m²]	Weight [kg]	Volume [dm³]	Code	Code	A [mm]	B [mm]	C [mm]	E [mm]	F [mm]	
16	pcs	750	50	0,02	0,03	AA976016001	WA976016001	33,7	29,9	15,7	24,2	30,0
20	pcs	400	50	0,03	0,05	AA976020001	WA976020001	30,0	32,3	16,0	24,4	34,5
25	pcs	400	50	0,05	0,06	AA976025001	WA976025001	35,3	38,0	16,0	28,0	39,5

Plastic double clip PP

System: **AQUA**
Material: PP-R
Standard: -

Note: Plastic clip for sliding point of parallel pipe on the wall.

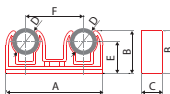

Code	Quantity	Area [m²]	Weight [kg]	Volume [dm³]	Code	Code	A [mm]	B [mm]	C [mm]	E [mm]	F [mm]	
2 x 16	pcs	500	50	0,01	0,04	AA976016002	WA976016002	65,3	30,2	15,9	24,2	40,4
2 x 20	pcs	450	50	0,02	0,05	AA976020002	WA976020002	70,5	34,8	15,9	25,5	43,4
2 x 25	pcs	200	50	0,03	0,06	AA976025002	WA976025002	89,0	40,0	15,8	27,8	54,7

Plastic clip with stirrup

System: **AQUA**
Material: PP-R
Standard: -

Note: Plastic clip with stirrup for sliding point of pipe on the wall and ceiling.

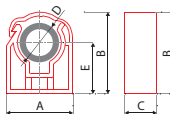

Code	Quantity	Area [m²]	Weight [kg]	Volume [dm³]	Code	Code	A [mm]	B [mm]	C [mm]	E [mm]	
15	pcs	600	50	0,01	0,03	AA977015001	WA977015001	25,0	33,5	16,0	22,5
16	pcs	600	50	0,01	0,03	AA977016001	WA977016001	26,0	34,0	16,0	23,0
18	pcs	600	50	0,01	0,03	AA977018001	WA977018001	28,0	36,5	16,0	24,0
20	pcs	400	50	0,02	0,04	AA977020001	WA977020001	31,0	38,0	16,0	25,0
22	pcs	400	50	0,02	0,04	AA977022001	WA977022001	33,0	40,5	16,0	26,0
25	pcs	400	50	0,02	0,04	AA977025001	WA977025001	35,0	43,5	16,0	28,0

Plastic double clip with stirrup

System: **AQUA**
Material: PP-R
Standard: -

Note: Plastic clip with stirrup for sliding point of parallel pipe on the wall and ceiling.

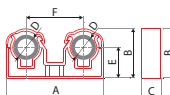

Code	Quantity	Area [m²]	Weight [kg]	Volume [dm³]	Code	Code	A [mm]	B [mm]	C [mm]	E [mm]	F [mm]	
15	pcs	200	50	0,02	0,06	AA977015002	WA977015002	61,2	33,5	16,0	22,5	36,2
18	pcs	300	50	0,02	0,06	AA977018002	WA977018002	70,2	36,5	16,0	24,0	42,2
20	pcs	300	50	0,04	0,08	AA977020002	WA977020002	76,2	38,0	16,0	25,0	45,2
22	pcs	300	50	0,04	0,08	AA977022002	WA977022002	81,2	40,5	16,0	26,0	48,2
25	pcs	150	50	0,04	0,08	AA977025002	WA977025002	90,2	43,5	16,0	28,0	55,2

Spacing clip for cold water

System: **AQUA**
 Material: PP-R for 16–25, PS for 25–50
 Standard: -

Note: Universal plastic clip for sliding point of pipes of different diameters on the wall and ceiling.

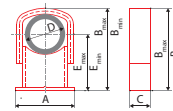

Icon	⊕	⊞	⊞	⊞	dm ²	# ●	# ●	A [mm]	Bmin [mm]	Bmax [mm]	C [mm]	Emax [mm]	E [mm]
16–25	pcs	200	50	0,01	0,05	AA978016025	WA978016025	43,2	42,0	51,5	29,5 (32)	30,0	34,5
25–50	pcs	50	25	0,05	0,20	AA978025050	WA978025050	70,2	76,5	101,5	35,4 (38)	56,5	69,0

Plastic clip with strap

System: **AQUA**
 Material: PP-R
 Standard: -

Note: Reliable clip with strap for sliding point of pipe on the wall and ceiling.

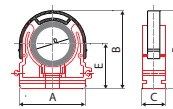

Icon	⊕	⊞	⊞	⊞	dm ²	# ●	A [mm]	B [mm]	C [mm]	E [mm]
32	pcs	400	50	0,02	0,05	AA979032000	52,5	54,7	15,8	31,8
40	pcs	300	50	0,03	0,06	AA979040000	63,4	63,6	15,8	36,6
50	pcs	150	25	0,04	0,16	AA979050000	80,2	77,0	18,7	40,4
63	pcs	100	25	0,05	0,19	AA979063000	96,3	91,0	18,9	46,6
75	pcs	60	1	0,10	0,38	AA979075000	120,1	90,6	24,1	62,5
90	pcs	40	1	0,12	0,50	AA979090000	138,7	129,3	24,2	68,3
110	pcs	30	1	0,15	0,64	AA979110000	164,0	149,2	24,0	78,3

Metal sleeve

System: **AQUA**
 Material: -
 Standard: -

Note: For fixing point, also suitable for vertical pipeline. Creates a fixing point - must be taken into account when planning compensation.



Icon	⊕	⊞	⊞	⊞	dm ²	#			
20	pcs	100	1	0,04	0,04	AA980020000			
25	pcs	100	1	0,04	0,04	AA980025000			
32	pcs	100	1	0,05	0,05	AA980032000			
40	pcs	100	1	0,06	0,06	AA980040000			
50	pcs	50	1	0,07	0,16	AA980050000			
63	pcs	50	1	0,11	0,19	AA980063000			
75	pcs	50	1	0,16	0,38	AA980075000			
90	pcs	50	1	0,19	0,50	AA987090000			
110	pcs	50	1	0,25	0,64	AA980110000			

Screw combi

System: **AQUA**
 Material: -
 Standard: -

Note: Screw for metal sleeve.



Icon	⊕	⊞	⊞	⊞	dm ²	#			
M8 x 100	pcs	100	1	0,04	0,04	AA981008100			

Dowels

System: **AQUA**
 Material: PP-R
 Standard: -

Note: High quality dowels with square cross section and thick wall.

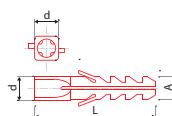

□	⊕	⊞	⊞	⊞	⊞	#	A [mm]	d [mm]	L [mm]
6 mm	set	800	20	0,01	0,03	AA982006000	5,6	6	30
8 mm	set	480	20	0,02	0,04	AA982008000	7,5	8	40
10 mm	set	170	10	0,03	0,07	AA982010000	9,5	10	50
12 mm	set	120	10	0,04	0,13	AA982012000	11,7	12	60

Threaded bar

System: **AQUA**
 Material: galvanized steel
 Standard: -

Note: Threaded rod made of high quality galvanized steel.



□	⊕	⊞	⊞	⊞	⊞	#			
M8 x 1000 mm	pcs	50	1	0,04	0,33	AA983008000			

Clamping strap

System: **AQUA**
 Material: -
 Standard: -

Note: Universal strap for tying multiple pipes together.



□	⊕	⊞	⊞	⊞	⊞	#			
7,6 x 400	pcs	100	1	0,01	0,01	AA984000000			

Plastic trough

System: **AQUA**
 Material: PVC-RE
 Standard: -

Note: Perspective plastic trough from PVC suitable for lead the pipes. Standard length 4m.



□	⊕	⊞	⊞	⊞	⊞	#			
120 x 100 x 4000 mm	m	1	1	1,75	12	AA985012004			

Trough cover plastic

System: **AQUA**
 Material: PVC-RE
 Standard: -

Note: Cover for trough with reliable set system. Standard length 1m. Color grey.



□	⊕	⊞	⊞	⊞	⊞	#			
146 x 30 x 1000 mm	m	1	1	1,3	4,38	AA986013001			

Galvanized trough (2 m length)

System: **AQUA**
 Material:
 Standard:

Note: Trough for a supporting lead of a pipe in spaces where you can not use clips.



							#			
16 x 2 m	pcs	25	2	0,29	0,26	AA987016002				
20 x 2 m	pcs	25	2	0,34	0,40	AA987020002				
25 x 2 m	pcs	25	2	0,44	0,63	AA987025002				
32 x 2 m	pcs	25	2	0,53	1,02	AA987032002				
40 x 2 m	pcs	20	2	0,62	1,60	AA987040002				
50 x 2 m	pcs	20	2	0,76	2,50	AA987050002				
63 x 2 m	pcs	15	2	0,90	3,97	AA987063002				
75 x 2 m	pcs	15	2	1,07	5,63	AA987075002				
90 x 2 m	pcs	10	2	1,11	5,63	AA987090002				

RPE pipe

System: **AQUA**
 Material: RPE
 Standard: -

Note: Special pipe for connection to the flushing systems etc.



							#			
	kg	1	1	1,00		AA988000000				

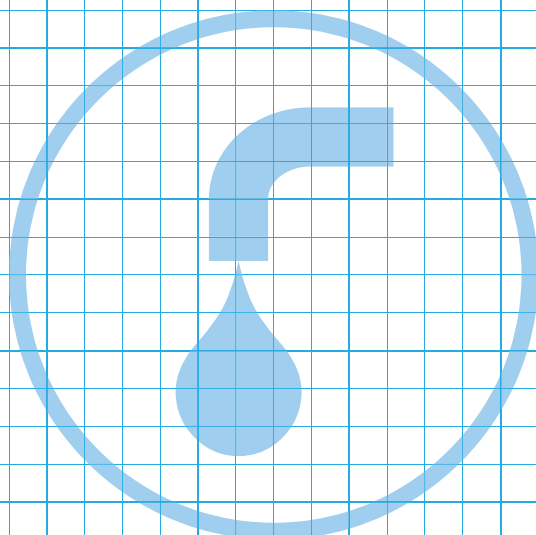



A unique invisible system for cooling, heating and ventilation all in one





COMFORT

Heating

- Heating system pipes
- System floorboards for heating
- Manifolds
- Valves and thermometers
- Mixing sets
- Cabinets
- Accessories
- Control
- Couplings – fittings
- Accessories
- Assembly instructions for underfloor heating

Cooling

- Cooling system pipes
- System ceiling tiles for cooling
- Manifolds
- Fittings
- Control
- Accessories
- Assembly instructions for cooling

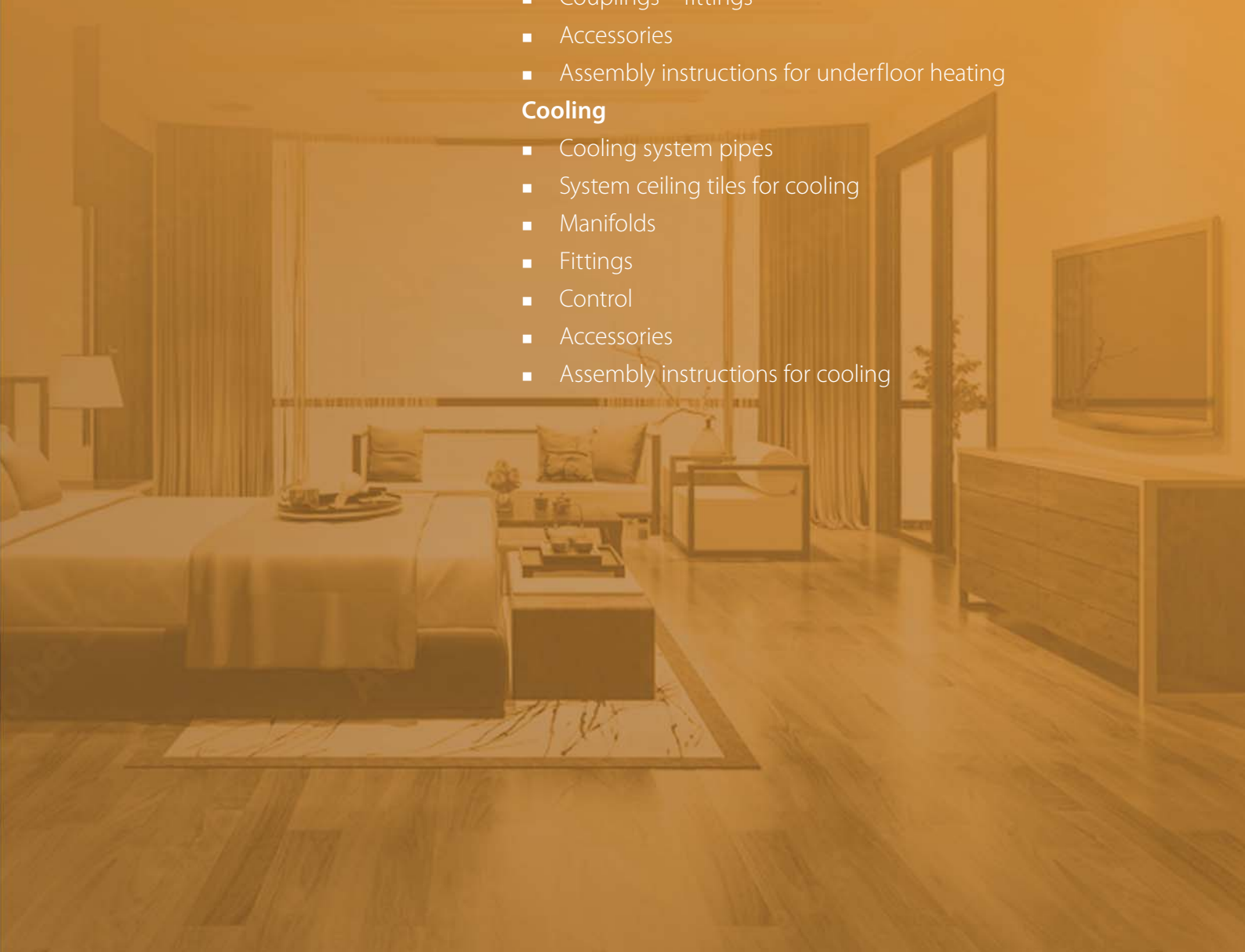

HEATING SYSTEM PIPES

FV MULTIPERT-5

System: **COMFORT**
 Material: PE-RT/EVOH/PE-RT
 Standard: EN ISO 22391, DIN 4726

Note: Five-layer, highly flexible polyethylene pipe PE-RT II with high heat resistance (acc. to EN ISO 22391), with an oxygen barrier of ethylene vinyl alcohol (EVOH) according to DIN 4726. Tmax 95°C.

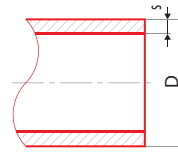

						#	D [mm]	s [mm]	l [m]
8 x 1,0	m	500		0,022	0,200	AA120008500	8	1	500
10 x 1,3	m	500		0,040	0,297	AA120010500	10	1,3	500
12 x 1,5	m	300		0,055	0,416	AA120012300	12	1,5	300
12 x 1,5	m	500		0,055	0,416	AA120012500	12	1,5	500
15 x 1,8	m	200		0,080	0,671	AA120015200	15	1,8	200
16 x 2,0	m	200		0,090	0,671	AA120016200	16	2	200
16 x 2,0	m	400		0,090	0,671	AA120016400	16	2	400
16 x 2,0	m	500		0,090	0,671	AA120016500	16	2	500
17 x 2,0	m	200		0,102	0,671	AA120017200	17	2	200
17 x 2,0	m	400		0,102	0,671	AA120017400	17	2	400
17 x 2,0	m	200		0,102	0,671	AA120017500	17	2	500
18 x 2,0	m	200		0,108	0,671	AA120018200	18	2	200
18 x 2,0	m	400		0,108	0,671	AA120018400	18	2	400
18 x 2,0	m	500		0,108	0,671	AA120018500	18	2	500
20 x 2,0	m	200		0,116	0,671	AA120020200	20	2	200
20 x 2,0	m	400		0,116	0,671	AA120020400	20	2	400
20 x 2,0	m	500		0,116	0,671	AA120020500	20	2	500

FV MULTIPERT-AL

System: **COMFORT**
 Material: PE-RT/AL/PE-RT
 Standard: ČSN EN ISO 21003, DIN 4726

Note: Five-layer, polyethylene pipe PE-RT II with an longitudinally welded aluminium layer. Increased heat resistance (acc. to EN ISO 22391). Oxygen barrier of aluminum according to DIN 4726. Tmax 95°C.

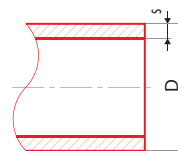

						#	D [mm]	s [mm]	l [m]
16 x 2,0	m	200	foil	0,105	0,60	AA130016200	16	2,0	200
16 x 2,0	m	400	foil	0,105	0,60	AA130016400	16	2,0	400
18 x 2,0	m	200	foil	0,123	0,60	AA130018200	18	2,0	200
20 x 2,0	m	200	foil	0,148	0,60	AA130020200	20	2,0	200
20 x 2,0	m	100	foil	0,074	0,60	AA130020100	20	2,0	100

SYSTEM BOARDS

FV EPS insulated mounting mate in roll

System: **COMFORT**

Material: EPS

Standard: EN 13163

Note: Heat and sound insulation EPS base (according to DIN EN 13163) (WLS 045) with a grid patterned durable waterproof polyethylene membrane to prevent water and humidity leak. Grid enables easy pipe fixing with tackler staples.



					#	for Ø D	pitch [mm]	netto area [m ² /pc]	load capacity [kN/m ²]	thermal conductivity [W/m.K]
1 m × 10 m × 30 mm	m ²	10	0,6	36,18	AA900010030	14–20		1,00	4	0,04

FV system foil with grid

System: **COMFORT**

Material: EPS/AL

Standard: -

Note: System reflective foil with a grid of 5x5 cm for underfloor heating. For easy attachment of pipes using clips. The film protects the EPS floor boards against the penetration of moisture and the screed itself during the creation of the floor. Tear resistance, covering vapor barrier layer for underfloor heating and also functioning as a separation film.

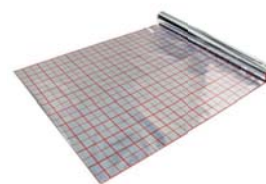

					#	for Ø D	pitch [mm]	netto area [m ² /pc]	load capacity [kN/m ²]	thermal conductivity [W/m.K]
1,02 m × 50 m × 0,105 mm	pcs	50	2,53	2,50	AA900001000	16–20		1,00	3,5	

FV NOP SOLO system mat

System: **COMFORT**

Material: PS

Standard: EN 13163

Note: Universal mat of durable PS film with studs. For heating pipes with diameters 16–18 mm. Enables 38 mm or 75 mm spacing. Special rim for easy connection of mats.



					#	for Ø D	pitch [mm]	netto area [m ² /pc]	load capacity [kN/m ²]	thermal conductivity [W/m.K]
1400 × 800 × 21 mm	pcs	180	0,975	10,92	AA902003000	16–18	50/70	1,12	unlimited	

FV NOP ISO system mat with 11 mm insulation

System: **COMFORT**

Material: EPS/PS

Standard: EN 13163

Note: Combined thermal and sound insulation of EPS 11 mm with a layer resistant to deep-drawn PS foil formed into the shape of studs. A suitable mat for heating pipes with diameters of 16, 17 and 18 mm, with a rim for easy connection to other mats. System mat for floor heating allows quick and easy installation with minimum of pruning.

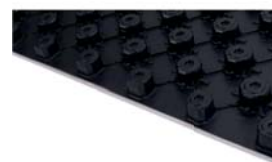

					#	for Ø D	pitch [mm]	netto area [m ² /pc]	load capacity [kN/m ²]	thermal conductivity [W/m.K]
1400 × 800 × 11 mm	pcs	14	1,286	31,875	AA902002011	16–18	50/70	1,12	4,6	0,035

FV NOP ISO PLUS system mat with 30 mm insulation

System: **COMFORT**
 Material: EPS/PS
 Standard: EN 13163

Note: Combined thermal and sound insulation of EPS 30 mm with a layer resistant to deep-drawn PS foil formed into the shape of studs. A suitable mat for heating pipes with diameters of 16–18 mm, with a rim for easy connection to other mats. System mat for floor heating allows quick and easy installation with minimum of pruning.



					#	for Ø D	pitch [mm]	netto area [m ² /pc]	load capacity [kN/m ²]	thermal conductivity [W/m.K]
1400 × 800 × 30 mm	pcs	8	1,75	57,08	AA902001030	16–18 mm	50	1,12	5	0,035

FV DR system board with 30 mm insulation for dry construction

System: **COMFORT**
 Material: EPS/AL
 Standard: EN 13163

Note: Special system board for dry floor construction. 30 mm EPS board with a layer of laminated AL foil and grooves for laying system heating pipes with a diameter of 16 mm. The underfloor heating system board enables quick and simple installation with minimal cutting. Connection with DK or DKS boards.

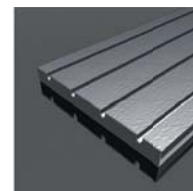

					#	for Ø D	pitch [mm]	netto area [m ² /pc]	load capacity [kN/m ²]	thermal conductivity [W/m.K]
960 × 480 × 30 mm	pcs	17	0,476	16,58	AA903000960	16	120/240	0,4608	5	0,035

FV DK end system board with 30 mm insulation for dry construction

System: **COMFORT**
 Material: EPS/AL
 Standard: EN 13163

Note: Special end system board for dry floor construction. 30 mm EPS board with a layer of laminated AL foil and grooves for laying system heating pipes with a diameter of 16 mm. The underfloor heating system board enables quick and simple installation with minimal cutting. Connection with DR or DKS boards.



					#	for Ø D	pitch [mm]	netto area [m ² /pc]	load capacity [kN/m ²]	thermal conductivity [W/m.K]
480 × 240 × 30 mm	pcs	34	0,119	4,14	AA903000240	16	120/240	0,1152	5	0,035

FV DKS end system board with 30 mm insulation for dry construction

System: **COMFORT**
 Material: EPS/AL
 Standard: EN 13163

Note: Special end system board with groove for dry floor construction. 30 mm EPS board with a layer of laminated AL foil and grooves for laying system heating pipes with a diameter of 16 mm. The underfloor heating system board enables quick and simple installation with minimal cutting. Connection with DR or DK boards.



					#	for Ø D	pitch [mm]	netto area [m ² /pc]	load capacity [kN/m ²]	thermal conductivity [W/m.K]
480 × 320 × 30 mm	pcs	34	0,158	5,53	AA903000320	16	120/240	0,1536	5	0,035

FV RENO special mat for floor reconstruction

System: **COMFORT**
 Material: PS
 Standard: EN 13163

Note: A low-height mat made of PS with studs. Designed for the floor heating installations on original old floors. For heating pipes with diameter of 10–12 mm



					#	for Ø D	pitch [mm]	netto area [m ² /pc]	load capacity [kN/m ²]	thermal conductivity [W/m.K]
1050 × 650 × 16 mm	pcs	16	0,84	11,44	AA904001000	10–12	50/43	0,60	bez omezení	

FV clamping rail

System: **COMFORT**

Material: PP

Standard: -

Note: A Clamping rail for easy laying of system pipes with height fixation and adhesive tape for quick fixing to the base. Minimum span of pipes 50 mm, length 1000 mm. Universal for pipes with diameters of 16-20 mm.

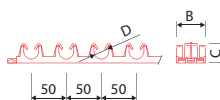

					#	D [mm]	B [mm]	C [mm]
16-20 x 1000 mm	pcs	100	1,168	0,83	AA905003000	16-20	40	28

FV staple for clamping rail

System: **COMFORT**

Material: PP

Standard: -

Note: Staple for fixing a universal clamping rails. Staple securely holds the clamping rail in the EPS mats even when used in dusty spaces. It delivers in white color.

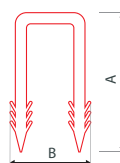

					#	D [mm]	A [mm]	B [mm]
	pcs	200	0,002	0,009	AA909000058		58	27

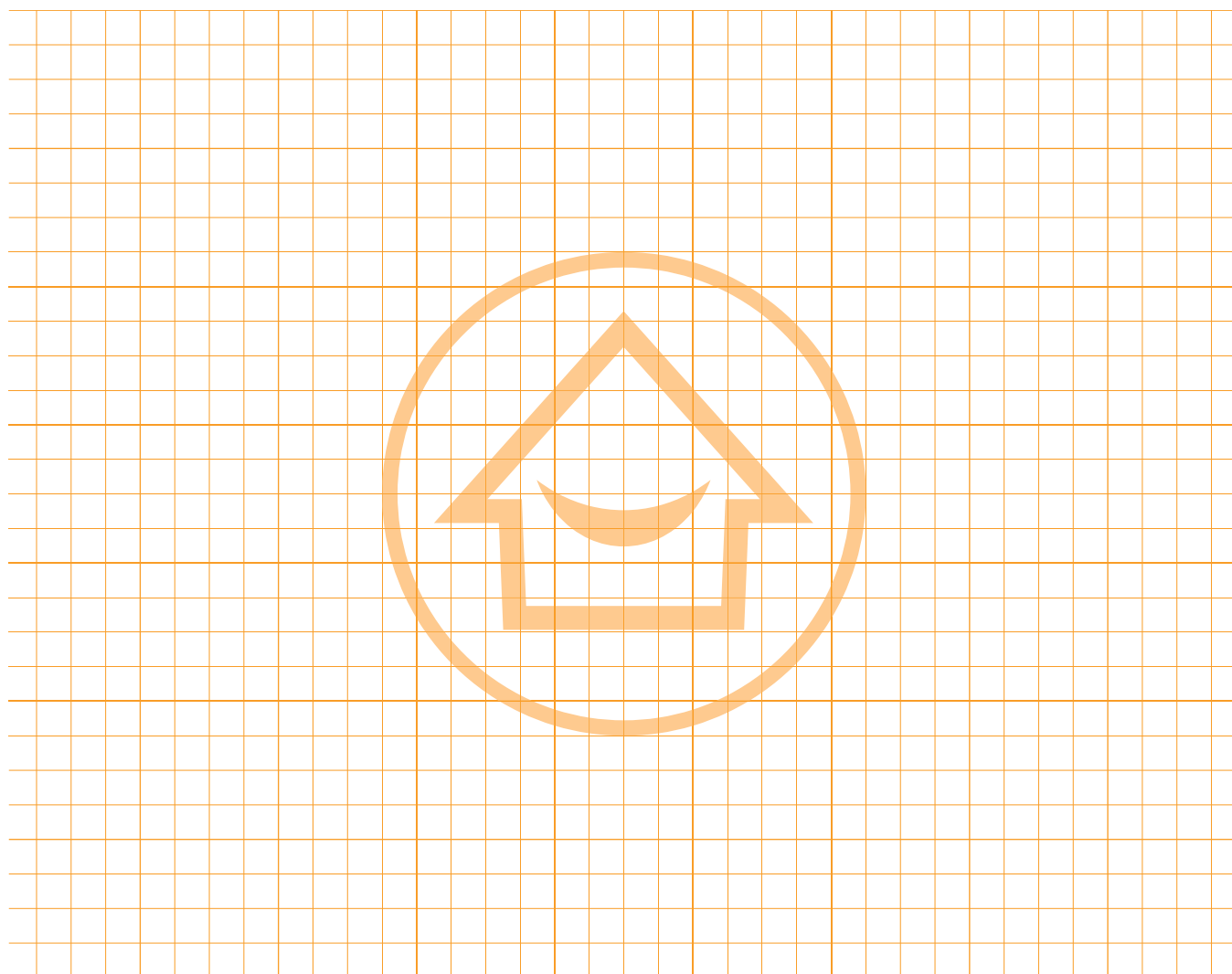

MANIFOLDS SUITABLE FOR COMFORT SYSTEMS



FOR HEATING AND
COOLING

PUSH ADAPTERS
QUICK MOUNTING

DOES NOT CORRODE

MAXIMUM
TEMPERATURE 90 ° C

COMFORT MANIFOLDS

Complete stainless steel manifolds with flow meters for COMFORT underfloor heating and ceiling cooling systems



INOX

1 "STAINLESS STEEL DISTRIBUTOR INOX FOR UNDERFLOOR HEATING WITH EUROCONUS

Applicable pipe diameters: **d10 × 1.3 mm – d20 × 2.0 mm**

Applicable liquids: **water or glycol solutions up to a maximum concentration of 50%**

Operating temperature: **5–55 °C**

Maximum temperature: **60 °C**

The operating pressure: **0–6 bar**

Maximum pressure **10 bar**

Distance between outlets / valves: **50 mm**

Range of adjustable holders: **210–273 mm**

Cabinet depth: **> 76 mm**

 **COMFORT**

MANIFOLDS

FV manifold with Eurocone INOX

System: **COMFORT**
 Material: stainless steel
 Standard: -

Note: Stainless steel manifold with a spacing of 50 mm and connected to a 1" AG power supply. With excellent temperature resistance, max 90 °C at 3 bar pressure and minimum temperature expansion. For water and glycol heating fluids with a max.concentration of 50 %. Working temperature from 5 to 55 °C. Working pressure 0 – 6 bar. The heating pipe diameter D10 – D20 mm can be connected to the manifold by means of Euroconus M3/4" connector. There are dry flowmeters with a scale from 0 to 5 l/min. The return circuits are fitted with shut off valves with the possibility of connecting a M30 x 1,5 mm thermal actuator. In set with adjustable holders with spacing from 200 to 250 mm. The total thickness of the manifold including the bracket for wall or cabinet mounting is 76 mm.



							# ●	number of circuits	B [mm]
192 mm	pcs	1	1	1,58	8,4	AA906001002		2	192
242 mm	pcs	1	1	1,93	8,4	AA906001003		3	242
292 mm	pcs	1	1	2,28	8,4	AA906001004		4	292
342 mm	pcs	1	1	2,63	9,6	AA906001005		5	342
392 mm	pcs	1	1	2,98	10,7	AA906001006		6	392
442 mm	pcs	1	1	3,33	11,9	AA906001007		7	442
492 mm	pcs	1	1	3,68	11,9	AA906001008		8	492
542 mm	pcs	1	1	4,03	14,1	AA906001009		9	542
592 mm	pcs	1	1	4,38	15,3	AA906001010		10	592
642 mm	pcs	1	1	4,73	16,4	AA906001011		11	642
692 mm	pcs	1	1	5,08	17,6	AA906001012		12	692
742 mm	pcs	1	1	5,43	18,7	AA906001013		13	742
792 mm	pcs	1	1	5,78	19,8	AA906001014		14	792
842 mm	pcs	1	1	6,13	21,0	AA906001015		15	842

TAPS AND THERMOMETERS

FV ball valve 1" int/ext thread

System: **COMFORT**
 Material:
 Standard: ČSN EN ISO 228

Note: Ball valve with connection 1" and colored butterfly handle. Field of use -10 °C to +95°C.

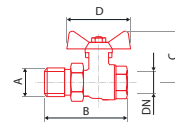

						# ●	# ●	A [mm]	B [mm]	C [mm]	D [mm]
1"	pcs	72	6	0,53	0,36	AA926001001		1"	88	57	67
1"	pcs	72	6	0,53	0,36		AA926002001	1"	88	57	67

FV thermometer for manifold

System: **COMFORT**
 Material:
 Standard: -

Note: Thermometer for measuring input and output temperature on manifold. Field of use min. 0 °C to 120 °C.

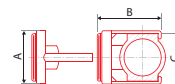

						# ●	# ●	A [mm]	B [mm]	C [mm]
1"	pcs		1	0,03	0,09	AA927000001		∅ 45,5	55	40,8
1"	pcs		1	0,03	0,09		AA927000002	∅ 45,5	55	40,8

MIXING SETS

FV mixing set

System: **COMFORT**

Material: Brass

Standard: -

Note: Mixing set for floor heating with heating surface. The kit includes valves with inlet temperature control. It includes a Wilo PARA 15-130 circulation pump, a three-way valve, a By-pass and a thermometer at the inlet to the distributor. 235 mm pitch with 1" connection.



Icon	⊕	⊞	⊠	⊡	dm ³	#	B [mm]
	pcs	1	4,10	10,50	AA906100180	219	

CABINETS

FV manifold cabinet on plaster

System: **COMFORT**

Material: steel

Standard: -

Note: Cabinet divider on plaster. Made of sheet steel, white powder coating. Rear wall with mounting bracket for mounting the distributor and electrical accessories. Cabinet depth 145 mm, lockable/removable door.



Icon	⊕	⊞	⊠	⊡	dm ³	#
450 mm	pcs	1	1	6	41,00	AA907000046
585 mm	pcs	1	1	6,5	48,00	AA907000058
725 mm	pcs	1	1	7,8	61,00	AA907000072
810 mm	pcs	1	1	9,5	73,00	AA907000081
980 mm	pcs	1	1	10	91,00	AA907000098
1115 mm	pcs	1	1	10,4	95,00	AA907000111

FV manifold cabinet under plaster

System: **COMFORT**

Material: steel

Standard: -

Note: Concealed distributor cabinet. Made of sheet steel, white powder coating. Rear wall with mounting bracket for mounting the distributor and electrical accessories. Cabinet depth 145 mm, lockable/removable door.



Icon	⊕	⊞	⊠	⊡	dm ³	#
470 mm	pcs	1	1	6,4	43,00	AA908000047
600 mm	pcs	1	1	7,2	57,00	AA908000060
750 mm	pcs	1	1	8,4	69,00	AA908000075
830 mm	pcs	1	1	9,5	73,00	AA908000084
1000 mm	pcs	1	1	11	91,00	AA908000100
1095 mm	pcs	1	1	11,2	93,50	AA908000101

ACCESSORIES

FV tacker staple

System: **COMFORT**
 Material: PP
 Standard: -

Note: High quality harpoon-shaped staples for fixing 15-20mm pipes onto the FV THERM EPS system roll. Stacked by 50 pcs for easy staple gun filling.



Icon	Symbol	Symbol	Symbol	Symbol	dm ³	#			
40 mm	pcs	1	300	0,0018	0,010	AA909000040			
50 mm	pcs	1	250	0,0021	0,013	AA909000050			

FV edge belt

System: **COMFORT**
 Material: PE
 Standard: -

Note: Special mounting area edge belt made of 8mm thick and 150mm height polyethylene foam (PE) with 280mm wide polyethylene film attached.



Icon	Symbol	Symbol	Symbol	Symbol	dm ³	#			
150 mm	m	400	25	1,00	15,00	AA910150050			

FV PE protecting tube

System: **COMFORT**
 Material: PE
 Standard: -

Note: Polyethylene (PE) protective tube designed to protect the heating pipes running through the dilatation joints and to the manifold.



Icon	Symbol	Symbol	Symbol	Symbol	dm ³	#			
25 mm x 50 m	pcs		50 m	6,00	0,35	AA911025050			

FV expansion profile

System: **COMFORT**
 Material: PE
 Standard: -

Note: The expansion profile is made of PE foam with closed cell structure. It is used for perfect spatial separation of dilated fields and creates permanently elastic joints in concrete and anhydrite floors. The self-adhesive adhesive layer on the underside of the inverted T-profile enables easy and quick installation. The width of the created expansion joint is 8 mm, height 100 mm. The length of 1 pieces is 2 m.



Icon	Symbol	Symbol	Symbol	Symbol	dm ³	#			
100 x 2000 mm	m	220	2	0,07	2,236	AA912100200			

FV direction diverter "click"

System: **COMFORT**
 Material: nylon + C
 Standard: -

Note: A direction diverter click 0 - 90° for protection and fixing pipes to pass trough ceiling and input to manifold.



Icon	Symbol	Symbol	Symbol	Symbol	dm ³	#	D [mm]	length [mm]	
15	pcs	25	1	0,060	0,116	AA913015000	15	150	
16-17	pcs	25	1	0,060	0,116	AA913017000	16-17	153	
18-20	pcs	25	1	0,060	0,116	AA913018020	18-20	175	

FV fixing plastic bend

System: **COMFORT**

Material: nylon + C

Standard: -

Note: A bend 90° for protection and fixing pipes to pass trough ceiling and input to manifold. Universal for diameters 14-18 mm and 20-22 mm.



Icon	⊕	⊞	⊞	⊞	⊞	#	D [mm]	length [mm]
14-18	pcs	400	1	0,04	0,26	AA913014018	14-18	160
20-22	pcs	400	1	0,06	0,55	AA913020022	20-22	160

FV self-adhesive tape

System: **COMFORT**

Material: -

Standard: -

Note: Durable self-adhesive tape 50mm width, 66m length.



Icon	⊕	⊞	⊞	⊞	⊞	#		
50 mm x 60 m	pcs	10	1	0,01	0,10	AA914050060		

REGULATIONS

FV Actuator NC- Thermal drive - 230 V

System: **COMFORT**

Material: plastic

Standard: -

Note: It provides control of the individual manifold valves. Variant NC (close when current-free) Cover: IP65 Distribution: height 70 mm, diameter approximately 45 mm, cable length 1m. Input power: 2,5W / 230 V. Connection: outlet nut M30 x 1,5



Icon	⊕	⊞	⊞	⊞	⊞	#	height [mm]	diameter [mm]	cable length [mm]
	pcs	1	1	0,146	0,36	AA916000000	70	45	1000

FV thermostatic controller

System: **COMFORT**

Material: -

Standard: -

Note: Electronic single room temperature controller 230 V. To be used in combination with servo drives.



Icon	⊕	⊞	⊞	⊞	⊞	#		
230 V	pcs		1	0,20	0,10	AA917000000		

FV electronic switching module

System: **COMFORT**

Material: -

Standard: -

Note: Electronic switching module for connecting up to 24 servodrives and 6 thermostatic controllers. To be mounted on DIN rail.



Icon	⊕	⊞	⊞	⊞	⊞	#		
24-230 V	pcs		1	0,40	3,00	AA918000000		

COUPLINGS - FITTINGS

FV transition union to the distributor (Eurocone 3/4")

System: **COMFORT**

Material: -

Standard: -

Note: Threaded connector for connecting FV MULTIPERT heating pipes to the manifold.



Icon	Symbol	Symbol	Symbol	Symbol	dm ³	#			
10 x 1,3	pcs		10	0,10	0,03	AA920010000			
12 x 1,5	pcs		10	0,10	0,03	AA920012000			
15 x 1,8	pcs		10	0,10	0,03	AA920015000			
16 x 2,0	pcs		10	0,10	0,03	AA920016000			
17 x 2,0	pcs		10	0,10	0,03	AA920017000			
18 x 2,0	pcs		10	0,10	0,03	AA920018000			
20 x 2,0	pcs		10	0,10	0,03	AA920020000			

FV coupling

System: **COMFORT**

Material: -

Standard: -

Note: Reliable brass coupling. It consists of a dual MS threaded connection and two transition unions for connecting the pipes.



Icon	Symbol	Symbol	Symbol	Symbol	dm ³	#			
10 x 1,3	pcs		10	0,10	0,07	AA921010000			
12 x 1,5	pcs		10	0,10	0,07	AA921012000			
15 x 1,8	pcs		10	0,10	0,07	AA921015000			
16 x 2,0	pcs		10	0,10	0,07	AA921016000			
17 x 2,0	pcs		10	0,10	0,07	AA921017000			
18 x 2,0	pcs		10	0,10	0,07	AA921018000			
20 x 2,0	pcs		10	0,10	0,07	AA921020000			

FV reducing sleeve male 3/4"

System: **COMFORT**

Material: brass - nickel-plated

Standard: -

Note: Reliable pipe coupling. It consists of transition union and 3/4" male thread.

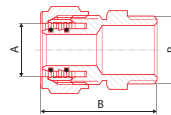

Icon	Symbol	Symbol	Symbol	Symbol	dm ³	#	A	B [mm]	R
15 x 3/4"	pcs	1	1	0,085	0,135	AA924015034	15	38	3/4"
16 x 3/4"	pcs	1	1	0,088	0,135	AA924016034	16	40	3/4"
17 x 3/4"	pcs	1	1	0,090	0,135	AA924017034	17	40	3/4"
20 x 3/4"	pcs	1	1	0,111	0,135	AA924020034	20	43	3/4"

FV plug female 3/4

System: **COMFORT**
 Material: brass - nickel-plated
 Standard: -

Note: For closing non-use branches of manifold. The possibility of establishing reserves for future expansion. Field of use min 0 - 120 °C

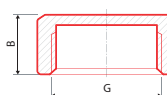

Icon	Unit	Grid	Grid	Weight	Volume	#	A	B [mm]
	pcs		1	0,034	0,027	AA925020034	3/4"	12

ACCESSORIES

FV Tacker - fixing gun

System: **COMFORT**
 Material: -
 Standard: -

Note: Special fixing tool for fixing pipes Ø 14 - 20 mm on the mats. Height-adjustable, for fixing pipes using the original harpoon - staples.



Icon	Unit	Grid	Grid	Weight	Volume	#
	pcs		1	7,00	15,00	AA922000000

FV Tacker - fixing gun plastic

System: **COMFORT**
 Material: -
 Standard: -

Note: Special fixing tool for fixing pipes Ø 14 - 20 mm on the mats. Height-adjustable, for fixing pipes using the original harpoon - staples.



Icon	Unit	Grid	Grid	Weight	Volume	#
	pcs		1	1,75	22,30	AA923000001

FV horizontal decoiler

System: **COMFORT**
 Material: Fe - galvanized
 Standard: -

Note: For unwinding of the heating pipes up to the length of 600 meters. Maximum load 90kg, the maximum coil diameter of about 260mm, a maximum width of 420mm.



Icon	Unit	Grid	Grid	Weight	Volume	#	Ø [mm]	height [mm]
	pcs		1	16,00	45,29	AA923001000	1140	548

ASSEMBLY INSTRUCTIONS FOR UNDERFLOOR HEATING

AQUA

COMFORT

ENERGEO

INFRA

The underfloor heating system is designed for heating apartments, family houses, administrative and shopping centers and industrial buildings. The basis is high-quality FV MULTIPERT-5 pipes with an oxygen barrier made of EVOH, specially designed for underfloor heating, the use of which for these purposes is the most economical. Top-quality FV MULTIPERT-AL pipes with a longitudinally welded aluminum layer can also be used.

Due to the arrangement of the heating pipes on the insulation layer, the underfloor heating system is classified as a wet laying system in design group A according to DIN 18560-2. See Picture no. 1, 2.

Picture no. 1: Construction type A - Systems with screed pipes

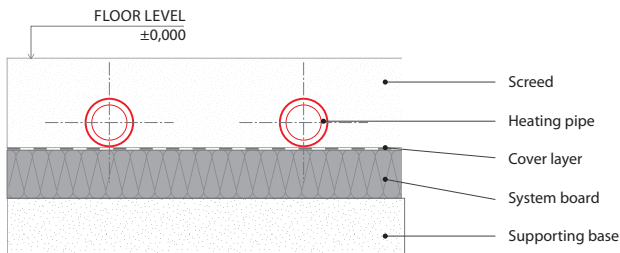

Picture no. 2: Construction type B - Systems with pipes under screed

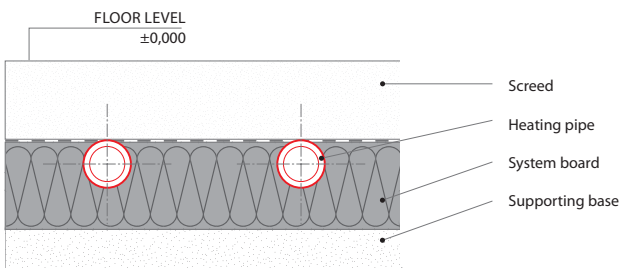

1. FIELD SIZES AND EXPANSION JOINTS

The screed is implemented in accordance with DIN 18560-1. Additional screeds may be used for better processing of cement screeds. The grain size of the screed sand should be between 0-8 mm. Screed fields should not exceed 40 m² with a joint ratio of 1:1 or 1:2. Arrangement of expansion fields and joints see Picture. No.3. For areas below 40 m², expansion joints should be used if the side length exceeds 8 m or protruding components (corners, pillars, chimneys) limit the shape of the screed plate.

Expansion joints may only be crossed by a connecting line in one level by means of a protective pipe with a length of min. 200 mm on each side of the joint.

For every 200 m² of screed area, three measuring points must be taken into account to measure the residual moisture. The design of the heating circuits must correspond to the size and shape of the screed plate (see Picture. 3). In the case of anhydrite cast screeds, the arrangement of the joints must be consulted with the screed manufacturer.

It is necessary to make joints in the screed (movement joints) and in the final floor covering above the expansion joints of the building. In addition, the screed must be separated from the vertical components by joints (edge joints). If reactive joints are arranged in the screeds, they may be cut to a maximum of one third of the screed thickness. A joint plan must be drawn up for the arrangement of the joints, which shows the type and arrangement of the joints. The joint plan is prepared by the construction designer and submitted as part of the performance descriptions of the implementing company.

Picture no. 3: Arrangement of fields and expansion joints

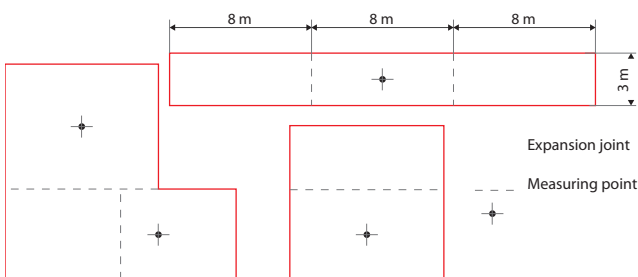

Picture no. 4: Expansion joint of heating screed

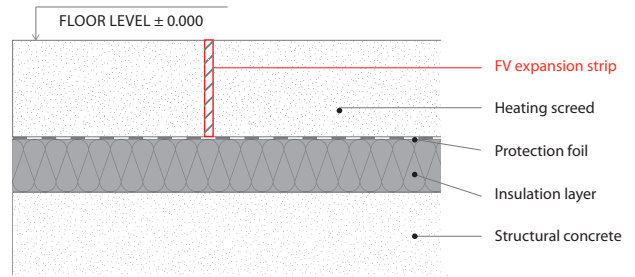

Picture no. 5: Expansion joint of heating screed when laying hard floor coverings (tiles, stone floor, laminate floor)

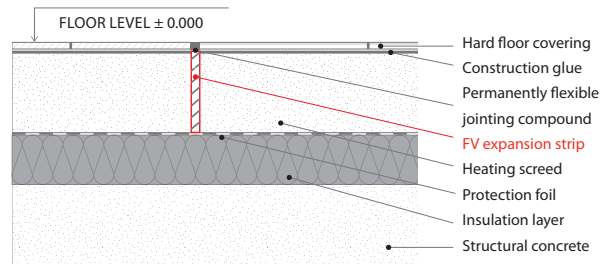

Picture no. 6: Expansion joint of heating screed when laying hard floor coverings with separating layer (tiles, stone floor, laminate floor)

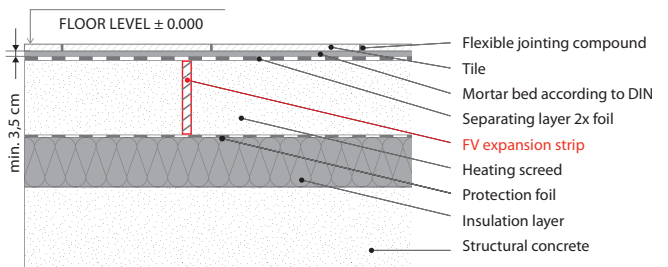

Picture no. 7: Expansion joint of heating screed when laying soft floor coverings (PVC, linoleum, carpet)

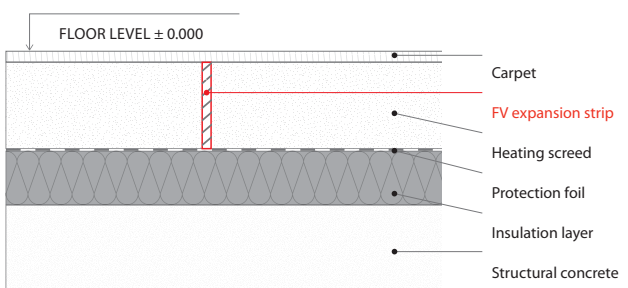

Expansion joints are made according to the project of the joint plan. If a construction expansion joint is made, it is necessary to make it without interruption even in the place of underfloor heating. If a hard floor covering is used, it is necessary to add the expansion joint in this layer as well (see Picture no. 5).

The heating pipe must be protected by FV PE protector when crossing risk areas (expansion joints, door transitions, passages through walls).

Only the supply and return pipes to the individual circuits, not the circuit pipes, can be led through the expansion joint in the protector. The minimum length of the pipe protector (see Picture no. 8) is 20 cm on each side of the expansion joint. The minimum width of the expansion joint is 8 mm.

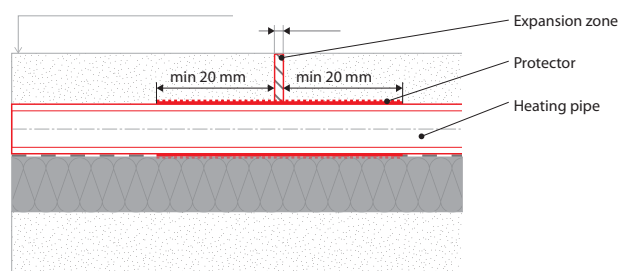

Picture no. 8: Protection of the heating pipe when passing through the expansion zone of the FV PE protector

2. PIPES FOR UNDERFLOOR HEATING

The FV MULTIPERT-5 pipes are among the high-quality, inspected and certified products. After delivery to the construction site, plastic pipes must be stored, processed and manipulated in such a way that:

- were protected from any damage
- the heating pipes have not been exposed to direct sunlight
- storage time in unprotected storage did not exceed 3 months
- were stored on a flat surface that shows no sharp edges
- were protected from oils, fats, paints and prolonged exposure to sunlight

Polyethylene heating pipes FV MULTIPERT-5

Continuous operating temperature:	+ 70 °C
Max. short-term temperature load:	+ 90 °C (max. 2 years)
The operating pressure:	4 bar
Meets all the requirements of ISO 10508 for class 4 + 5	
Minimum bending radius	5 x d (d=outer pipe diameter)
Installation temperature:	from -5 °C to + 30 °C
DIN Registration Number:	3V 204 PE-RT

Five-layer highly flexible system pipe made of PE-RT with increased temperature resistance according to EN ISO 22391, with oxygen barrier according to DIN 4726, with increased protection against mechanical damage during transport and manipulation on the construction site. Packaging of 200 m in a strapped bundle in a cardboard package, or after 400 m in a strapped bundle in a protective foil.

Oxygen permeability at 40 °C is well below the limit specified in DIN 4726. Using the HP method, the EVOH barrier layer is inseparably connected to the base pipe.

2.1. UNDERFLOOR HEATING INSTALLATION PROCEDURE

Electrical and sanitary installations, interior plastering and window work must be completed before insulation and surface heating. For plasters, it is necessary that they are stretched directly to the supporting base of the floor. Before starting installation work on the underfloor heating system, the specialist must check the flatness of the raw floor using a meter line. The maximum height tolerance is 1 cm for the entire area of the installed room. Meter lines are usually marked in the section of doorways during construction. They are usually marked with a circle or by other method. Dimensional tolerances must be observed in accordance with DIN 18202 (tolerances in building construction). The flatness must be checked before laying the insulation. Any major inequalities must be removed / leveled. Remains of plaster and other impurities must be removed from the floor.

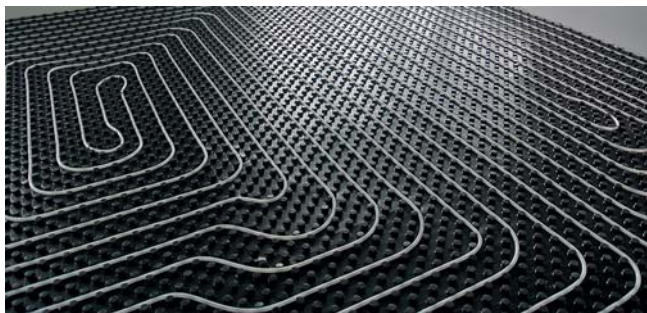

Picture no. 9: Underfloor heating piping

Floor surfaces bordering the ground must be provided with insulation against moisture, according to DIN 18195 (building insulation). The definition of the exact construction insulation is specified by the designer or architect. The craftsman in charge

of laying the insulation must check the suitability of the seal and communicate any concerns with the waterproofing to the construction management in writing. If bitumen seals, eg bituminous strips, are installed, it is necessary to lay an intermediate layer of 0.1 mm thick polyethylene foil before laying the insulation. The foil is laid freely on the seal. Pipes laid on the floor must be properly fastened and secured against slipping or floating. To achieve a proper floor structure, it is necessary to lay leveling insulation. An additional level of insulation can then be laid on the lower insulation. Compensating insulation may only be made of "hard" insulation (EPS-DEO, PUR, etc.). For laying insulation from several layers, the joints of individual layers must not overlap, but alternate, see. Picture no. 11.

3.1. INSTALLATION OF THE FV EDGE INSULATION STRIP

The edge insulation strip must be carefully made on all vertical building components such as columns, door openings, fireplace, elevator shaft, etc. In the case of thermal insulation of a building consisting of several layers, the edge strip can be installed before the last insulation layer is laid. The attached foil apron of the edge strip must be laid in such a way that the edge joint between the thermal and impact insulation is completely covered and the screed is prevented from flowing, resp. water. The edge joints must reach from the supporting base to the roof surface and allow the screeds to move at least 5 mm. The edge strip must be secured against position changes during screed installation. The insulating edge strip, which is located above the screed board after pouring, may only be cut off after the top floor layer has been laid, resp. for textile and elastic coverings only after the trowel has hardened. The reason is also to prevent acoustic bridges and construction damage.

All grouting and troweling work on the floor and the walls adjacent to the floor must be completed by cutting off the protruding part of the edge strip. After cutting off the protruding part of the edge strip, the floor skirting boards are installed.

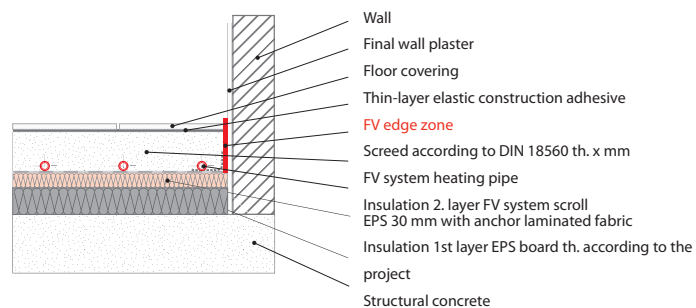

Picture no. 10: Fitting the FV edge strip

3.2. INSTALLATION OF SYSTEM BOARDS

The choice of system boards depends on the requirements for thermal and impact insulation according to the valid ENEC / DIN4109 / DIN4108 standards. The insulation layers and system boards are laid on a flat, load-bearing surface. If installation or electrical cables are laid on the raw floor, these must be insulated and a place must be created for them in the insulation under the underfloor heating.

The first layer of multilayer insulation must be modified so that a full-area substrate and a continuous closed area are created for the EPS / system board. In the case of two-layer laying, the layers must be installed with offset joints. The multilayer "sandwich" foil on the upper side of the system rolls / boards represents the covering layer of the insulating layer according to DIN 18560.

The one-sided overlap of the foil serves to cover the joints. The front joints must always be glued with FV self-adhesive tape. Filler parts that are inserted without foil overlap must be glued around the perimeter. Before using the poured screed, all joints must be glued very carefully to prevent the screed from leaking, resp. distribution water. It is necessary to interrupt the arrangement of insulating materials on the expansion joints of buildings and maintain the expansion joint. The maximum permissible floor installation height must be observed in any case.

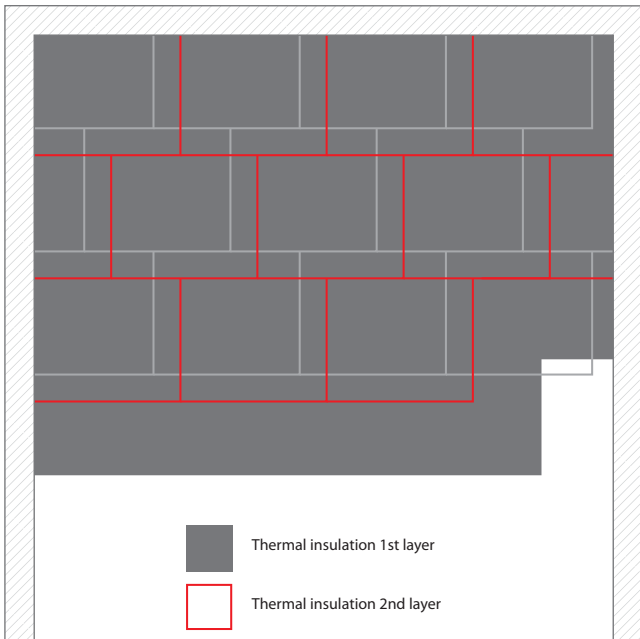

Picture no. 11 Laying more insulation layers under underfloor heating

3.3. INSTALLATION OF THE UNDERFLOOR HEATING MANIFOLD CABINET

Floor circuit manifolds are installed in cabinets. In addition to the manifold, the cabinet contains shut-off ball valves and valves for filling and venting the system. Furthermore, components for control or pump and mixing are located in the cabinet. The cabinet is installed to the required height from the level of the final floor before mounting the circuits. In the case of a sufficient wall thickness on which the manifold box is placed, it is possible to use a flush-mounted FV cabinet. In case of insufficient thickness, the FV cabinet is mounted on the wall.

3.4. LAYING OF SYSTEM HEATING PIPES

Pipe laying begins by attaching the heating pipes to the supply manifold. When tightening the fittings (size 30), a mating piece (size 24) must always be held on the manifold. It is also necessary to observe the maximum tightening torque of 30N. The ends of the pipes must be separated at right angles without burrs. The place of transition of the pipes from the floor to the wall is protected by inserting the pipe into the FV click guide elbow, which allows to fix the bend in the range from 0 - 90°, or a high-quality FV fixing plastic bend.

The pipes are attached to the surface of the EPS FV system roll using the FV tacker stapling needles and the original FV tacker system stapler. Tacker FV clamps are placed at intervals of approx. 50 cm at the straight part of the heating pipes; when changing direction, the spacing must be reduced to approx. 30 cm. Alternatively, mounting rails can be placed on the insulation and the pipes placed in them.

When laying, the following distances of the first pipe must be observed for:

- vertical components: 50 mm
- elevators, shafts, chimneys, fireplaces: 200 mm

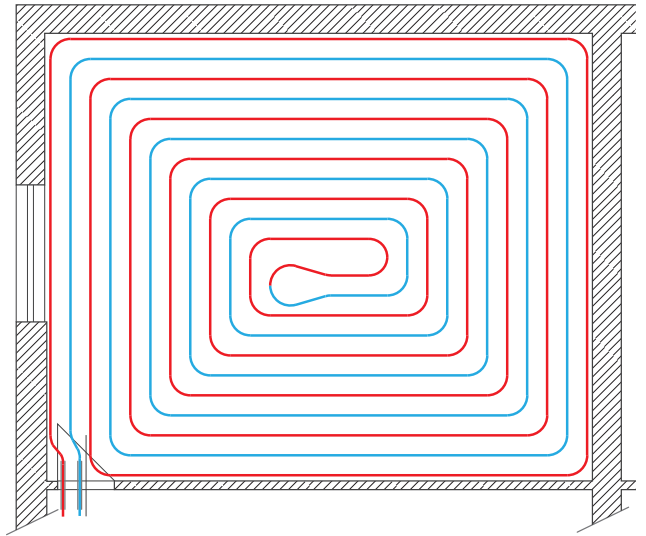

Picture no. 12: Spiral piping

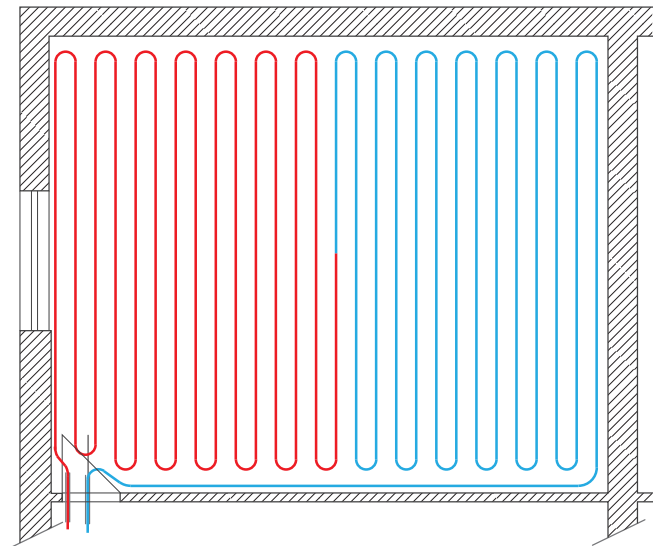

Picture no. 13: Meandering piping

The minimum bending radius $5xd$ (pipe outer diameter) must not be reduced in accordance with DIN 4726. The heating pipes can be laid in a spiral or meander shape.

Due to the more even heat distribution, spiral laying is to be preferred. With this type of installation, we achieve a constant temperature profile in the floor. In places that are more cooled (north wall, wall with a large window, or glass wall, etc.), a pipe with a smaller spacing is laid than in the residential area, and an edge zone is created. The edge zone can be part of a circuit or form a separate circuit.

When laying the return loops in the middle of the heating circuit, the minimum dimensions of the corresponding bending radius according to DIN 4726 sxd (d = outer diameter of the heating pipe) must be observed. The minimum bending radius for 15×1.8 mm pipes is 75 mm and for $17 \times 2,0$ mm pipes it is 85 mm. In the case of a sharp bend, proceed as shown in Picture no.14, for a $17 \times 2,0$ mm pipe, $r = 17 \times 5 = 85$ mm, a loop length of 197 mm and a width of 170 mm.

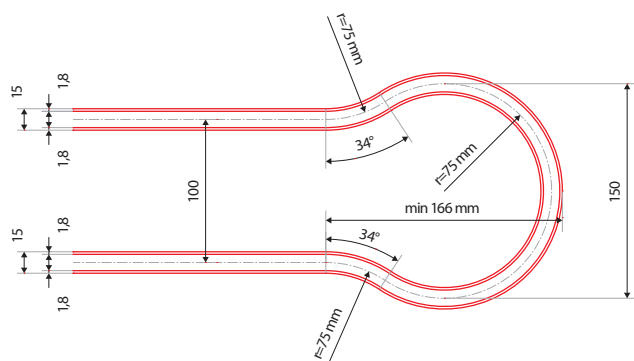

Picture no. 14:

Fractures (sharp bends that occur if the minimum bend radius of the pipe is not observed) must be removed. Couplings can only be mounted on straight pipe routes. The edge pipe is laid approx. 5 cm from the edge strip and is laid on PE foil, which is part of the edge strip. By fixing the first pipe to the substrate, we ensure that the grout does not flow under the foil.

When repairing the heating pipe or processing the remaining lengths, make sure that the FV compression fitting is located in a straight section of pipe, not in an arc. The FV clamp must be measured and marked in the construction documentation.

FLOOR SURFACE TEMPERATURES

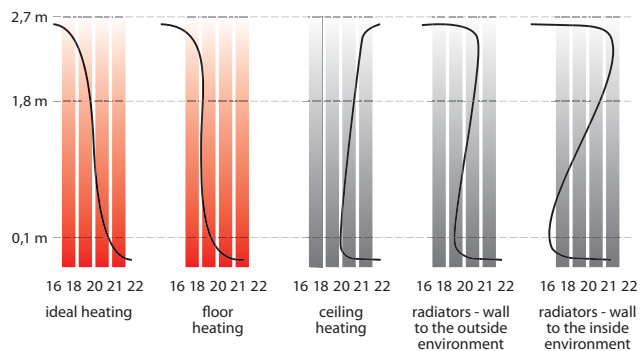

Picture no. 15: The course of the temperature curve. Comparison of "ideal heating" with FV THERM underfloor heating

The appropriate use of the room is decisive for determining the maximum surface temperature. According to DIN EN 1264, the maximum floor surface temperature in the living area must be limited to 29 °C (wet rooms 33 °C / edge zone 35 °C). Surface temperature, resp. the uniformity of the surface temperature of the surface heating is basically determined by the chosen floor covering.

The uniformity of the temperature course is determined by its heat transfer resistance, excessive temperature of the heating means, spacing during the laying of heating pipes and the chosen type of laying.

Living room floor surface temperatures at corresponding outdoor temperatures								
V ₂ [°C]	-15	-10	-5	±0	+5	+10	+15	+20
V ₁ [°C]~	+29,0	+27,5	+26,0	+25,0	+24,0	+23,0	+21,5	+20,0

FLOOR COMPOSITIONS WITH UNDERFLOOR HEATING IN THE FV THERM SYSTEM

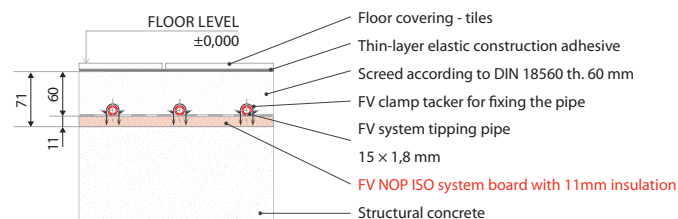

Picture no. 16: Recommended floor composition above heated rooms according to the recommendations of the ČSN EN 1264 standard thermal insulation resistance R = 0.75 m2K / W

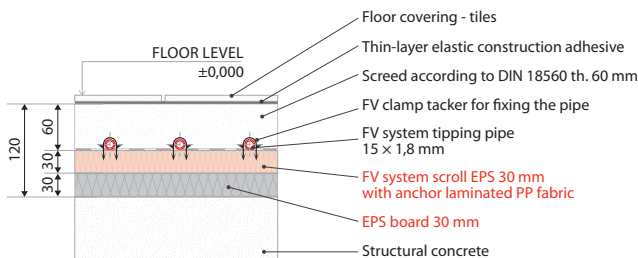

Picture no. 17: Recommended floor composition above heated rooms according to the recommendations of the ČSN EN 1264 standard thermal insulation resistance R = 1.25 m2K / W

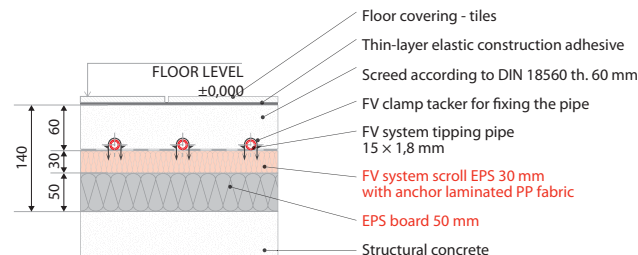

Picture no. 18: Recommended floor composition above heated rooms according to the recommendations of the ČSN EN 1264 standard thermal insulation resistance R = 2.00 m2K / W

4. FV UNDERFLOOR HEATING MANIFOLD

Due to the technical possibilities of regulation, it is recommended to assign a separate heating circuit to each room. If the room has a larger area than can be covered by one circuit, the room is divided into the corresponding number of heating circuits. Circuits longer than 120 m are not permitted. Multiple heating circuits can be part of one expansion unit.

The required heating circuit manifold results from the number of installed heating circuits. The recommended maximum pressure drop of the system (including manifold and connection fittings) is 250 mbar.

The manifold is designed so that it can be installed either on the wall or in the built-in manifold cabinet. The maximum number of circuits connected to one manifold is 12.

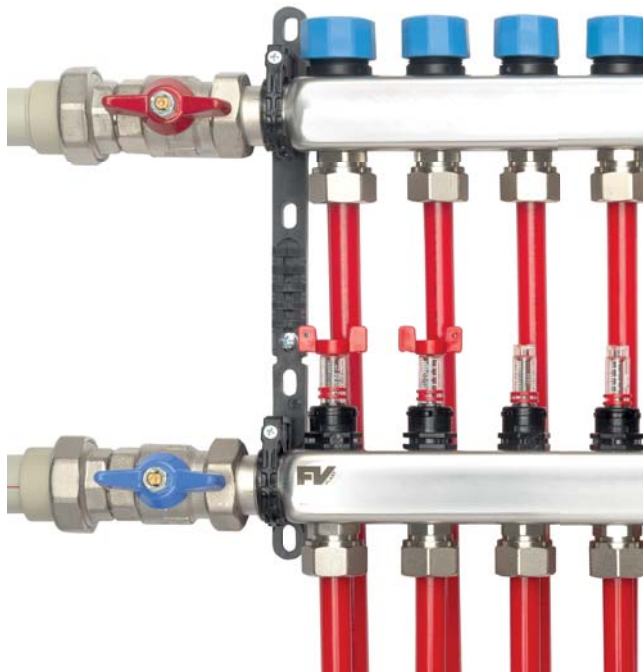

Picture no. 19: FV manifold with flow meters

The connection pipe from and to the source is with a 1"AG connection, optionally from the left or from the right.

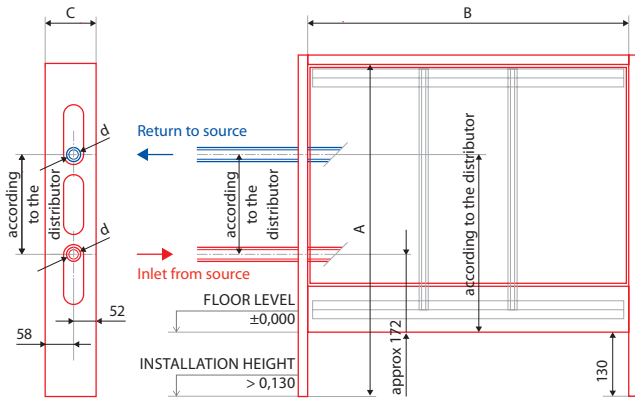

Picture no. 20: Inlet and return connection from the side - horizontally into the flush-mounted cabinet

5. LEAK TEST

After the installation work, the device must be professionally filled and the watertightness checked. The specifications of the VDI 2035 standard (damage prevention in hot water heating systems) must be observed.

All supply and return valves must be connected to the heating circuit switchboard. A hose must be connected to the filling tap from the water source. A hose ending in the drain or outside the house must be connected to the return valve. All circuits must be closed at the beginning of filling. After opening the supply valve, it is necessary to bleed the pipe of the supply switchboard. Then open the first supply valve and the first return valve.

If the heating circuit is completely filled with water so that no more air comes out at the free end, then the first heating circuit must be closed again. The same procedure must be followed for other heating circuits. At the end of the complete filling and venting process, all filling and draining valves are closed. All supply and return valves must then be opened. The water-filled system must now be subjected to a pressure test in accordance with the requirements of the ČSN EN 1264 standard. The pressure test must be carried out with water to prevent damage to the pipes. The test pressure is twice the operating pressure, but at least 6 bar (according to ČSN EN 1264-4). After two hours, the test pressure must be restored. Any pressure drop is usually due to pipe expansion. The duration of the test is 12 hours. The pressure test is successful if there are no water leaks.

at any point in the pipes, joints and connections and the test pressure does not drop by more than 0.1 bar per hour. A report must be drawn up on the performance of the pressure test. This protocol must be attached to the construction documentation.

To protect the heating system and safety devices, care must be taken to ensure that the ball valves of the connection set are closed during the pressure test.

6. HYDRAULIC ADJUSTMENT

After completing the leak test and before commissioning the system, the individual heating circuits must be set (according to DIN EN 1264 / ENEC). The setting values of the individual heating circuits must be determined in the project documents and set on the flow indicators of the supply valve.

7. PRODUCTION OF DAUB AND COMMISSIONING OF UNDERFLOOR HEATING

Filling of the underfloor heating pipes must always be carried out after a successful pressure test of the pipes with water, for which a report has been drawn up. The grouting is carried out on a pipe filled with water and pressurized to operating pressure. The daub must comply with DIN 1055.

Cement screed

A FV plasticizer is added to the cement screed for better coating of the pipe, flow of concrete around the entire pipe, also better heat transmission and, last but not least, against damage that may occur due to the content of aerating additives containing calcium or plasticizers, which are added to the screed mixture. or mixing water to the screed.

Calcium sulphate screeds and cement screeds must always be heated before laying floor coverings. The first re-heating of cement screeds may be carried out after 21 days at the earliest and of calcium sulphate screeds at the earliest after 7 days. The screed heating must be gradual. The temperature can be increased daily by max. 5 °C until the maximum operating temperature is reached. A report must be drawn up on the gradual heating of the heating plate.

Dosing of plasticizer into cement screed:

$$MS = 6.0 \cdot Ap \cdot tl. [kg]$$

where: Ap = floor area for floor heating [m^2]

$tl.$ = planned total screed thickness [m]

M_s = amount of FV plasticizer for concrete [kg]

Theoretical consumption of the FV plasticizer at a plate thickness of 45 mm above the pipe:

- Per $1m^2$ of concrete screed = 0.39 kg of plasticizer
- Per $1m^2$ of concrete screed = 6.0 kg of plasticizer

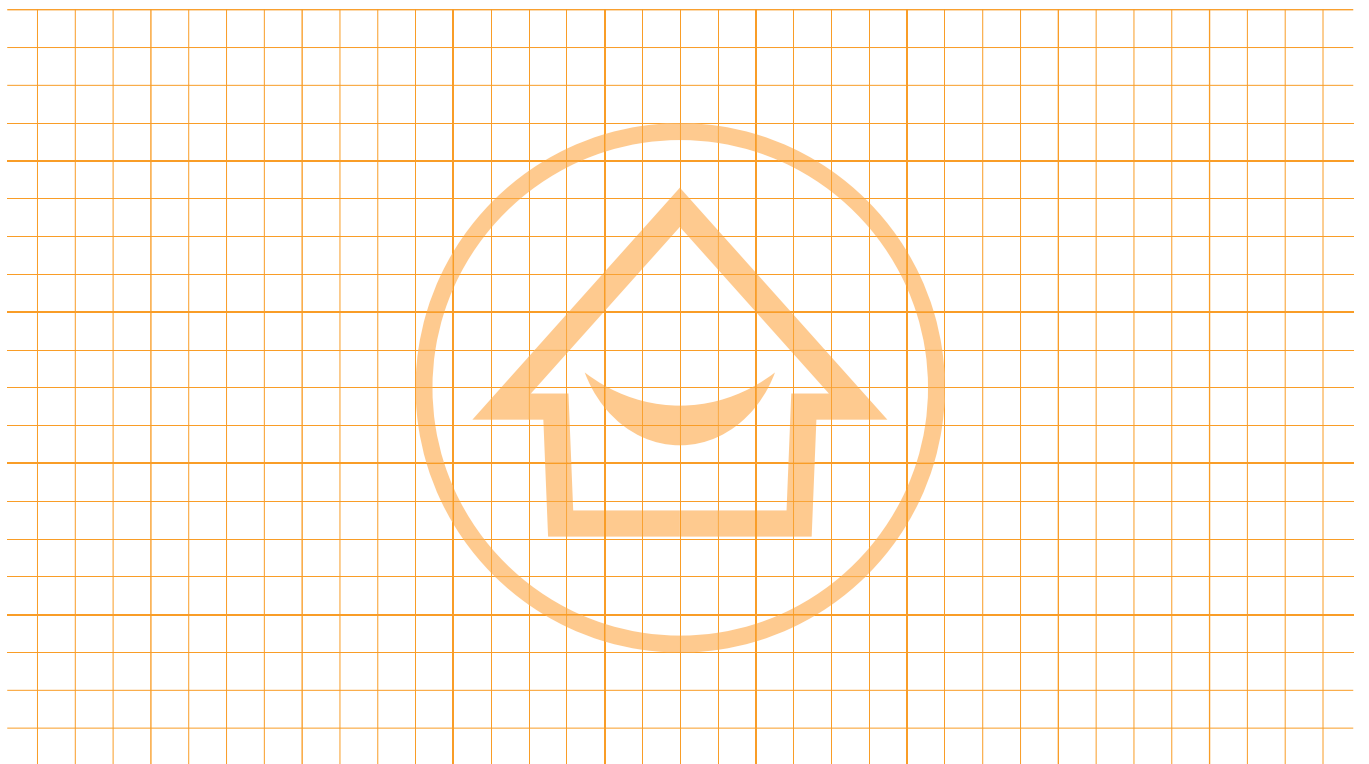

COOLING SYSTEM PIPES

FV COOLING PE-RT 16x2 mm

System: **COMFORT**

Material: PE-RT/EVOH/PE-RT

Standard: EN ISO 22391, DIN 4726

Note: 5 layers pipe for distribution of cooling and low-temperature heating. Pipe core from thermally resistant polyethylene is protected from air diffusion by special chemical conditioning EVOH. Maximal operational safe temperature 60°C, maximal working pressure 6 bar. Pipe surface is covered by polyethylene protective layer. Connection due to plug-in couplings and fittings.

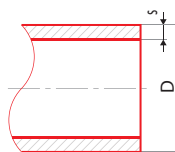

Icon	⊕	⊞	⊞	⊞	⊞	#	D [mm]	s [mm]	l [m]
16 x 2,0	m	180	1	0,092	0,330	AA960130110	16	2,0	3

FV COOLING PB 8x1 mm

System: **COMFORT**

Material: PB

Standard: ČSN EN ISO 15876, DIN 4726

Note: For registers line-up and forming of the active cooling and heating areas. Pipe core from thermally resistant polybutylene is protected from air diffusion by special chemical conditioning EVOH. Maximal operational safe temperature 60°C, maximal working pressure 6 bar. Pipe surface is covered by polybutylene protective layer. Connection due to plug-in quick couplings and fittings.

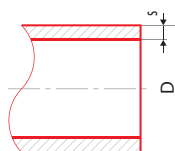

Icon	⊕	⊞	⊞	⊞	⊞	#	D [mm]	s [mm]	l [m]
8 x 1,0	m	600		0,022	0,200	AA960138120	8	1,0	600

SYSTEM BOARDS

High quality matt CoolFLEX

System: **COMFORT**

Material: PB, AL-foil, PE

Standard: -

Note: High quality matt Cool FLEX made of polybutylene FV PLAST COOLING PB 8x1 fused-in aluminium foil, which equally delivers first class heat in whole cooling area. It is made in the several variants: full matting for full metal ceiling cassettes, full matting for plasterboard - adapted for fastening on the soffit's steel grid and two types of perforated matting for plasterboard - for cooling of acoustic PBD soffits. Maximal operational safe temperature 50 °C, maximal working pressure 4 bar.



Icon	⊕	⊞	⊞	⊞	⊞	#	design	width [mm]	length [cm]	thickness [mm]	weight without water [kg/m²]	weight with water [kg/m²]
500–4000 mm	m²	40		1,03	13,00	AA96071BCCC	perforated cassette	B*	CCC**	8,5	1,03	1,73
500–4000 mm	m²	40		1,03	13,00	AA96072BCCC	full cassette	B*	CCC**	8,5	1,03	1,73
500–4000 mm	m²	40		1,03	13,00	AA96073BCCC	full SDK	B*	CCC**	8,5	1,03	1,73
500–4000 mm	m²	40		1,03	13,00	AA96074BCCC	perforated SDK	B*	CCC**	8,5	1,03	1,73

Note: **B*** width (1 – 180; 2 – 260; 3 – 340; 4 – 420; 5 – 500; 6 – 580; 7 – 660; 0 – 490 for SDK), **CCC**** length in cm

FV COOLING MATT CoolPLATE

System: **COMFORT**
 Material: PBD
 Standard: -

Note: Cooling pipes PB 8x1 are fixed in cutting grooves of anti-fire plasterboard, thickness 12.5 mm, groove spacing 40 mm. Each plasterboard has inlet length 1.2 m and due to plug-in quick couplings and fittings is connected with main supply. Maximal operational safe temperature 45 °C, maximal working pressure 4 bar.

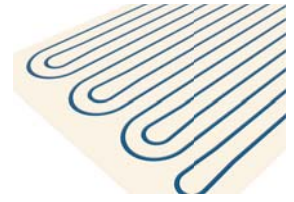

						#	width [mm]	length [mm]	thickness [mm]	1 pcs = area [m ²]
625 x 1000 mm	pcs	1		6,80	8,75	AA960130310	625	1000	12,5	0,625
625 x 2000 mm	pcs	1		13,50	17,50	AA960130320	625	2000	12,5	1,25
1250-2000 mm	pcs	1		13,50	17,50	AA960130330	1250	1000	12,5	1,25
1250-2000 mm	pcs	1		27,00	35,00	AA960130340	1250	2000	12,5	2,50

FV Plasterboard Thermalpanel

System: **COMFORT**
 Material: PBD
 Standard: -

Note: Special plasterboard panel with graphite admixture and increased thermal conductivity. Reaction to fire according to EN 13501-1: A2-s1, d0 (B).



						#	surface [mm]	thickness [mm]	thermal conductivity[W/(m.K)]
1250 x 2000 mm	pcs	1		10	10	AA960130418	2,5	10	0,45

DISTRIBUTORS

FV PLAST MANIFOLD PUSH 16, 0,6-2,4 l/min

System: **COMFORT**
 Material: Polyamide PA6.6 30% glass fibres
 Standard: -

Note: Plastic segment manifold is equipped on the return point with visual adjustable flowmeter with range 0.6-2,4 /min. on return point. Manifold bodies are equipped with loading and emptying valve, deaerating valve 1/2", and required amount of consoles is a part of the package. Manifold connection: 6/4 " external screw. Circuit connection due to quick-couplings PUSH for pipes of d16x2mm. Maximal operational safe temperature 70 °C.



						#	number of circuits	width B [mm]
	pcs	1	1	1,4	5,730	AA960116231	1	138
	pcs	1	1	1,9	5,730	AA960116232	2	192
	pcs	1	1	2,3	5,730	AA960116233	3	247
	pcs	1	1	2,8	5,730	AA960116234	4	302
	pcs	1	1	3,3	5,730	AA960116235	5	358
	pcs	1	1	3,7	8,378	AA960116236	6	414
	pcs	1	1	4,2	8,378	AA960116237	7	469
	pcs	1	1	4,7	8,378	AA960116238	8	524
	pcs	1	1	5,2	11,026	AA960116239	9	580
	pcs	1	1	5,6	11,026	AA960116240	10	635
	pcs	1	1	6,1	11,026	AA960116241	11	691
	pcs	1	1	6,6	13,675	AA960116242	12	746
	pcs	1	1	7,0	13,675	AA960116243	13	801
	pcs	1	1	7,5	13,675	AA960116244	14	856
	pcs	1	1	8,0	15,280	AA960116245	15	911
	pcs	1	1	8,5	16,243	AA960116246	16	966
	pcs	1	1	8,9	17,174	AA960116247	17	1021
	pcs	1	1	9,4	18,137	AA960116248	18	1076
	pcs	1	1	9,9	19,100	AA960116249	19	1131
	pcs	1	1	10,3	20,063	AA960116250	20	1186

FV PLAST MANIFOLD PUSH 16, 1-4 l/min

System: **COMFORT**
 Material: Polyamide PA6.6 30% glass fibres
 Standard: -

Note: Plastic segment manifold is equipped on the return point with visual adjustable flowmeter with range 1-4 /min. on return point. Manifold bodies are equipped with loading and emptying valve, deaerating valve 1/2", and required amount of consoles is a part of the package. Manifold connection: 6/4 " external screw. Circuit connection due to quick-couplings PUSH for pipes of d16x2mm. Maximal operational safe temperature 70 °C.



Icon	⊕	⊞	⊞	⊞	dm ³	#	number of circuits	width B [mm]	
	pcs	1	1	1,4	5,73	AA960116331	1	138	
	pcs	1	1	1,9	5,73	AA960116332	2	192	
	pcs	1	1	2,3	5,73	AA960116333	3	247	
	pcs	1	1	2,8	5,73	AA960116334	4	302	
	pcs	1	1	3,3	5,73	AA960116335	5	358	
	pcs	1	1	3,7	8,38	AA960116336	6	414	
	pcs	1	1	4,2	8,38	AA960116337	7	469	
	pcs	1	1	4,7	8,38	AA960116338	8	524	
	pcs	1	1	5,2	11,03	AA960116339	9	580	
	pcs	1	1	5,6	11,03	AA960116340	10	635	
	pcs	1	1	6,1	11,03	AA960116341	11	691	
	pcs	1	1	6,6	13,67	AA960116342	12	746	
	pcs	1	1	7,0	13,67	AA960116343	13	801	
	pcs	1	1	7,5	13,67	AA960116344	14	856	
	pcs	1	1	8,0	15,28	AA960116345	15	911	
	pcs	1	1	8,5	16,24	AA960116346	16	966	
	pcs	1	1	8,9	17,17	AA960116347	17	1021	
	pcs	1	1	9,4	18,14	AA960116348	18	1076	
	pcs	1	1	9,9	19,10	AA960116349	19	1131	
	pcs	1	1	10,3	20,06	AA960116350	20	1186	

FV MANIFOLD PUSH 16, 2-8 l/min

System: **COMFORT**
 Material: Polyamide PA6.6 30% glass fibres
 Standard: -

Note: Plastic segment manifold is equipped on the return point with visual adjustable flowmeter with range 1 – 4 l/min on return point. Manifold bodies are equipped with loading and emptying valve, deaerating valve 1/2", and required amount of consoles is a part of the package. Manifold connection: 6/4 " external screw. Circuit connection due to quick-couplings PUSH for pipes of d16x2mm. Maximal operational safe temperature 70 °C.



Icon	⊕	⊞	⊞	⊞	dm ³	#	number of circuits	width B [mm]	
	pcs	1	1	1,4	5,73	AA960116431	1	138	
	pcs	1	1	1,9	5,73	AA960116432	2	192	
	pcs	1	1	2,3	5,73	AA960116433	3	247	
	pcs	1	1	2,8	5,73	AA960116434	4	302	
	pcs	1	1	3,3	5,73	AA960116435	5	358	
	pcs	1	1	3,7	8,38	AA960116436	6	414	
	pcs	1	1	4,2	8,38	AA960116437	7	469	
	pcs	1	1	4,7	8,38	AA960116438	8	524	
	pcs	1	1	5,2	11,03	AA960116439	9	580	
	pcs	1	1	5,6	11,03	AA960116440	10	635	
	pcs	1	1	6,1	11,03	AA960116441	11	691	
	pcs	1	1	6,6	13,67	AA960116442	12	746	
	pcs	1	1	7,0	13,67	AA960116443	13	801	
	pcs	1	1	7,5	13,67	AA960116444	14	856	
	pcs	1	1	8,0	15,28	AA960116445	15	911	
	pcs	1	1	8,5	16,24	AA960116446	16	966	
	pcs	1	1	8,9	17,17	AA960116447	17	1021	
	pcs	1	1	9,4	18,14	AA960116448	18	1076	
	pcs	1	1	9,9	19,10	AA960116449	19	1131	
	pcs	1	1	10,3	20,06	AA960116450	20	1186	

FITTINGS

FV Spherical valve for dividers 6/4"-1"

System: **COMFORT**
 Material: Brass
 Standard: -

Note: Brassy spherical valve, for dividers FV Plast with outlet nut and sealing.



Icon	⊕	⊞	⊠	⊡	⊣	dm³	#	construction length [mm]	G	coupling nut G
	pcs	2	1	0,3	0,59	AA960117110		46	vnitřní 1/4"	6/4"

FV T-transitional quick coupling

System: **COMFORT**
 Material: PBT
 Standard: -

Note: It is used for quick plug-in connection of pipes FV COOLING PE-RT 16 x 2 and FV COOLIG PB 8 x 1.



Icon	⊕	⊞	⊠	⊡	⊣	dm³	#	supply diameter [mm]	pipe circuit [mm]
16-8-8-16	pcs	10	1	0,066	0,180	AA960134110		16	8-8
16-8-8	pcs	10	1	0,050	0,180	AA960134120		16	8-8
16-8-16	pcs	10	1	0,055	0,180	AA960134130		16	8

FV direct quick coupling

System: **COMFORT**
 Material: PBT
 Standard: -

Note: It is used for quick plug-in connection of pipes FV COOLING PB 8 x 1. Relieving cases are part of fittings packages.



Icon	⊕	⊞	⊠	⊡	⊣	dm³	#	1 pipe diameter [mm]	2 pipes diameter [mm]
8-8	pcs	10		0,015	0,05	AA960134210		8	8
16-16	pcs	10		0,038	0,12	AA960134220		16	16

FV Angular tube - quick coupling

System: **COMFORT**
 Material: PBT
 Standard: -

Note: It is used for quick plug-in connection of pipes FV COOLING PE-RT 16 x 2. Relieving cases are part of fittings packages.



Icon	⊕	⊞	⊠	⊡	⊣	dm³	#	supply diameter [mm]	supply diameter [mm]
8-8	pcs	10		0,066	0,050	AA960134310		8	8
16-16	pcs	10		0,045	0,120	AA960134320		16	16

FV Transition

System: **COMFORT**
 Material: Brass
 Standard: -

Note: Serves for connecting of pipe FV COOLING PE-RT 16x2 to external screw 1/2". Relieving cases are part of fittings packages.



Icon	⊕	⊞	⊠	⊡	⊣	dm³	#	pipe diameter [mm]	G
16-1/2"	pcs	10		0,045	0,04	AA960134510		16	1/2"
8-1/4"	pcs	10		0,034	0,04	AA960134511		8	1/4"
8-1/2"	pcs	10		0,014	0,03	AA960134512		8	1/2"

FV Blinder (sealing)

System: **COMFORT**
 Material: PP
 Standard: -

Note: Plug is used for blinding (sealing) of plug-in fittings.



Icon	⊕	⊞	⊞	⊞	⊞	#	pipe diameter [mm]		
	8 pcs	10			0,001	0,01	AA960134610	8	
	16 pcs	10			0,008	0,02	AA960134620	16	

FV Reinforcing sleeve 16 x 2 mm

System: **COMFORT**
 Material: Brass
 Standard: -

Note: For reinforcing of pipe in fitting to provide safe connection. Normally it is part of fittings package, must be separately ordered with manifold FV PUSH and as a spare part.



Icon	⊕	⊞	⊞	⊞	⊞	#	pipe diameter [mm]	thickness of the wall [mm]	
	pcs	20	1		0,004	0,06	AA960134720	16	2

REGULATIONS

FV Actuator NC- Thermal drive - 230 V

System: **COMFORT**
 Material: plastic
 Standard: -

Note: It provides control of the individual manifold valves. Variant NC (close when current-free) Cover: IP65 Distribution: height 70 mm, diameter approximately 45 mm, cable length 1m. Input power: 2,5W / 230 V. Connection: outlet nut M30 x 1,5



Icon	⊕	⊞	⊞	⊞	⊞	#	height [mm]	diameter [mm]	cable length [mm]	
	pcs	1	1		0,146	0,36	AA916000000	70	45	1000

FV Manual areal thermostat FV COOLING

System: **COMFORT**
 Material: plastic
 Standard: -

Note: Areal thermostat for regulation of the heating and cooling systems in two-pipe or four-pipe application. It enables direct connection up to 5 condensation point receptors.



Icon	⊕	⊞	⊞	⊞	⊞	#			
	pcs	1	1		0,11	0,33	AA960139315		

Condensation point receptor

System: **COMFORT**
 Material: plastic, metal
 Standard: -

Note: It records eventual risk of condensation and informs areal thermostat or condensation point convertor. Cable length: 10m. Placing: on feed pipe from distributor, in contact with internal area of room.



Icon	+	+	+	+	dm ³	#
	pcs	1	1	0,165	0,68	AA960139410

FV Condensation point receptor for plasterboard ceiling

System: **COMFORT**
 Material: plastic, metal
 Standard: -

Note: It record eventual risk of condensation and informs areal thermostat or condensation point convertor. It is equipped with buffering pipe for assembly to light soffit constructions. Cable length: 10m. Pipe length: 400 mm. Placing: on feed pipe from distributor, in contact with internal area of room.



Icon	+	+	+	+	dm ³	#
	pcs	1	1	0,25	2,1	AA960139420

FV Condensation point receptor

System: **COMFORT**
 Material: plastic
 Standard: -

Note: It serves as an convertor of the condensation point receptors and thermix regulation of the building within the areal cooling system applications. It detects status of the condensation point receptors and in case of the condensation risk it switches output potential-free relay contact. It enables parallel connection up to 5 condensation point receptors. Working voltage: 24 VAC, IP20, current consumption 40mA. Potential-free switch contact: 6 (2) A/230VAC



Icon	+	+	+	+	dm ³	#
	pcs	1	1	0,077	0,47	AA960139510

FV electronic switching module

System: **COMFORT**
 Material: -
 Standard: -

Note: Electronic switching module for connecting up to 24 servodrives and 6 thermostatic controllers. To be mounted on DIN rail.



Icon	+	+	+	+	dm ³	#
24-230 V	pcs		1	0,40	3,00	AA918000000

ACCESSORIES

FV Clamping bar PENTA

System: **COMFORT**
 Material: PP
 Standard: -

Note: For docking of ceiling cooling distribution from pipe 16x2mm. Bar is consisted of more separable parts with unlimited length extension option. Rated length: 1m, divided by 20cm. Pitch: 50mm. For pipes diameter: Ø14 - 18 mm.



Icon	⊕	⊞	⊠	⊡	⊣	dm ³	#	D [mm]	pitch [mm]	length [mm]
14-18 x 1,0 m	pcs	100	1	0,181	0,820	AA960112125	14-18	50	1000	

FV Conductive bar R 20 for pipe 8x1mm

System: **COMFORT**
 Material: PP
 Standard: -

Note: Firm plastic docking bar with low profile height, suitable mostly for ceiling and wall heating and cooling. It provides ideal application of pipe PB 8x1 and PE-RT 8x1.



Icon	⊕	⊞	⊠	⊡	⊣	dm ³	#	D [mm]	pitch [mm]	length [mm]
8 x 1 mm	pcs	200	1	0,068	0,280	AA960112127	8	25	800	

FV Arc console

System: **COMFORT**
 Material: PP
 Standard: -

Note: For fixation of cooling and heating registers arcs with the bar R 25. For pipes diameter: ø 8 mm.



Icon	⊕	⊞	⊠	⊡	⊣	dm ³	#	D [mm]		
14-18 x 1,0 m	pcs	100	1	0,008	0,110	AA960112128	8 x 1,0 mm			

ACCESSORIES

FV silicone paste for sealing O-circlets

System: **COMFORT**
 Material: Silicone
 Standard: -

Note: It is deposited prior to plugging in of the connecting screwing to pipe or anywhere else, where are used sealing o-circlets. Greasing substance prevents eventual mechanic damage of sealing while mouting.



Icon	⊕	⊞	⊠	⊡	⊣	dm ³	#			
	pcs	1	1,00	0,075	0,20	AA960991120				

ASSEMBLY INSTRUCTIONS FOR COOLING

1. SYSTEM USE

Ceiling cooling / heating FV KLIMA is a modern energy-saving surface cooling system. It is produced in several designs, adapted for different ceiling structures.

1.1. CoolFLEX SYSTEM FOR METAL CEILINGS (FULL OR ACOUSTIC)

The system consists of thin CoolFLEX cooling registers, which are housed in metal ceiling cassettes. CoolFLEX registers are tailor made according to the project specification. Cooling capacity is up to 75 W / m².

Installation

- The metal supporting structure is prepared according to the used coffered ceilings.
- The backbone distribution from the FV COOLING PE-RT 16 x 2 mm pipe and plug-in fittings is installed in the ceiling space.
- The CoolFLEX registers are stored in metal cassettes and connected to the backbone distribution system using quick connectors.
- Impregnation, leak test and function test will be performed.

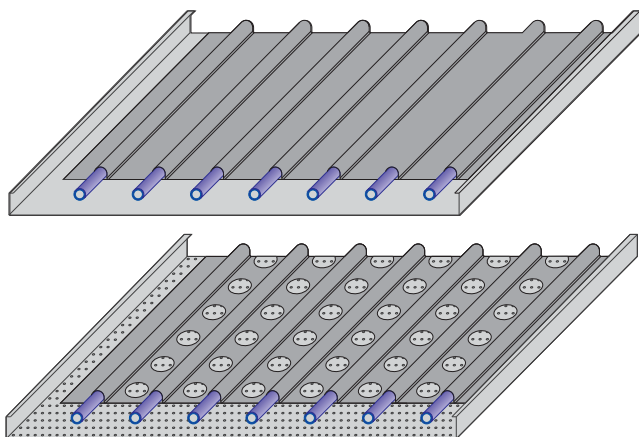

1.2. CoolFLEX SYSTEM FOR PLASTERBOARD CEILINGS (FULL OR ACOUSTIC)

The system consists of thin CoolFLEX cooling registers, which lie on plasterboard and offer easy and safe installation. To ensure maximum performance, gypsum boards with an admixture of graphite with increased thermal conductivity are used. For fastening, a standard metal construction designed for plasterboard ceilings is used, using CD and UD metal profiles. CoolFLEX registers are tailor made according to the project specification. Cooling capacity is up to 70 W / m².

Installation

- A metal supporting structure for SDK ceilings must be prepared. The spacing of the mounting CD profiles is 500 mm for solid ceilings and 333 mm for perforated acoustic ceilings.
- The backbone distribution from the FV COOLING PE-RT 16 x 2 mm pipe and plug-in fittings is installed in the ceiling space.
- The CoolFLEX registers are glued to the mounting profiles using pre-installed self-adhesive surfaces and connected to the backbone distribution using quick connectors.
- Impregnation, leak test and function test will be performed.
- Subsequently, the ceiling is covered with gypsum boards with thermal conductivity according to the project documentation.

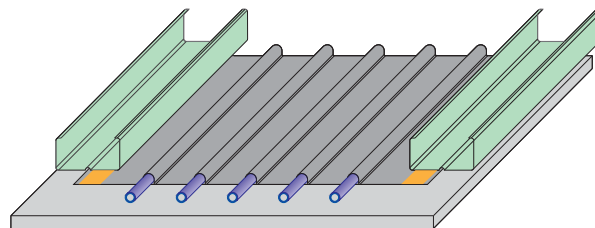

1.3. ACTIVE PLASTERBOARD CoolPLATE

The cooling pipes are placed in the plasterboard grooves. Individual CoolPLATE active cooling plates are tailor made according to the project specification. CoolPLATE active plasterboard is installed on a standard metal structure designed for lowered ceilings, using CD and UD profiles. Cooling capacity is up to 60 W / m².

Installation

- A metal supporting structure for SDK ceilings must be prepared. The spacing of the mounting CD profiles is 333 mm.
- The backbone distribution from the FV COOLING PE-RT 16 x 2 mm pipe and plug-in fittings is installed in the ceiling space.
- CoolPLATE active gypsum boards are attached to the mounting profiles and connected to the backbone distribution using quick connectors.
- Impregnation, leak test and function test will be performed.

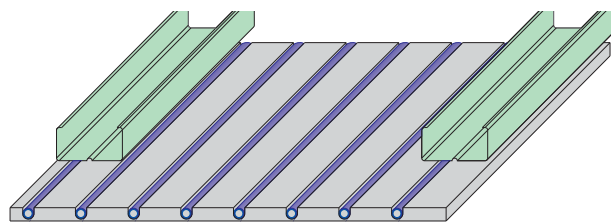

1.4. CONCEALED SYSTEM CoolGRID

CoolGRID cooling registers are placed in the ceiling plaster. They are used in combination with core or gypsum plaster in a thickness of 10 - 20 mm. CoolGRID cooling registers are delivered pre-made at the factory or are formed by placing the pipe in rails directly during assembly. Cooling capacity is up to 70 W / m² depending on the spacing and plaster mixture used.

CoolGRID system installation procedure

- The ceiling must meet the conditions of flatness of the substrate according to ČSN EN 13914-2 (5 mm / 2 m). The underlying concrete of the ceiling must be fresh and dry, it is necessary to remove dirt and grind the protrusions.
- In the rooms where the ceiling cooling system will be installed, the substrate will be adjusted in accordance with the technological regulations of the plaster mixture supplier.
- The backbone distribution from the FV COOLING PE-RT 16 x 2 mm pipe and plug-in fittings is installed
- Clamping rails for 8x1 mm pipes are attached to the ceiling surface at the prescribed intervals. It is best to fasten the slats with Ø 5 mm dowels or other suitable method
- The FV COOLING PB 8 x 1 mm pipe is placed in the rails and connected to the backbone distribution using quick connectors.
- Impregnation, leak test and function test will be performed.

Plastering the CoolGRID system

- For plastering the ceiling, we recommend using a suitable gypsum or core plaster mixture with a thermal conductivity corresponding to the project. The application follows the regulations of the mixture supplier.
- The minimum plaster thickness is 20 mm.
- The sizes of expansion joints are governed by the regulations of the plaster mixture used.
- When plastering, the system must be pressurized and the system pressure must be checked during the process.

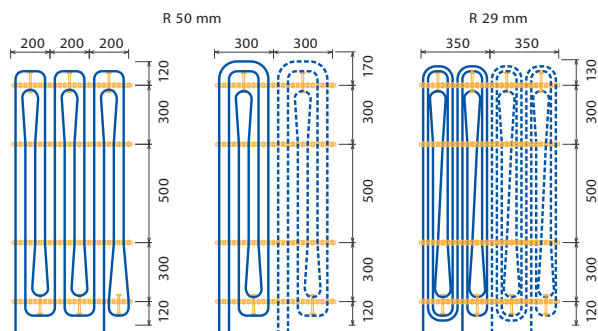

2. BASIC RECOMMENDATIONS FOR DESIGN AND INSTALLATION OF FV KLIMA SYSTEMS

- To prevent condensation, the ceiling must be dimensioned so that the inlet water temperature is always above the dew point temperature.
- The required height of the ceiling structure for the system of plasterboard and coffered ceilings is 6 - 20 cm.
- In the case of a plaster cooling ceiling system, a total plaster thickness of 2 cm is recommended.
- The optimal length of the circuit with a pipe $\varnothing 8 \times 1$ mm is 20 - 40 m.
- The optimal size of the active cooling surface per branch of the distribution pipe $\varnothing 16 \times 2$ mm is 10-15 m².
- Up to 15 cooling branches can be connected to the manifold.
- Each branch must be equipped with a control valve with a thermal actuator.
- The dew point sensor must be located in each room on the supply pipe.
- It is recommended to provide ventilation of the cooled rooms with conditioned air.
- When using the heating system, it is recommended to use an insulating material 3 - 5 cm thick above the cooling registers.
- When heating with a ceiling system, the heating water temperature is limited to 45 °C.
- The system can be filled with potable water without mechanical impurities.
- Expansion of cooling / heating ceilings must be designed and implemented according to the technical documents and recommendations of the manufacturers of plaster mixtures and plasterboard.

3 COMMISSIONING

After assembling and checking the whole system, the circuits are filled with clean water according to the following procedure:

- All circuits on the manifold are closed by turning the hand heads and flow meters.
- Pressurized water is led to the manifold filling valve and hoses are fitted to the collector drain valve and led to the sewer.
- The first circuit opens, the water is allowed to flow and when a clean stream of water without air flows, the circuit is closed by the valve and the flow meter.
- Subsequently, another circuit is opened and so all other circuits are gradually filled.
- Then, with the valves and flow meters closed, both manifold bodies are vented.
- All circuits are opened and a leak test is performed according to the following procedure.
- The system is pressurized to 6 bar, the pressure is maintained for 10 minutes and then quickly released.
- The system is pressurized to 2 bar, the pressure is maintained for 10 minutes and then quickly released.
- The system is pressurized to 4 bar. The pressure must not fall below 3.4 bar within 30 minutes. and after the next two hours below 3.2 bar.
- There must be no leaks during the test and a record of the test must be performed.
- The circulation pump is started and the projected flow in all branches is set by turning the flow meters.
- A functional control test is performed and the system is ready for use.

4. ASSEMBLY OF SYSTEM FITTINGS

The fittings are assembled according to the following work procedure. During the entire handling of fittings, it is necessary to pay close attention to the cleanliness of the fitting and the pipe, especially its sealing parts.



The pipe is cut with scissors perpendicular to the pipe axis. To prevent the pipe from flattening, it is advisable to turn the pipe using scissors.

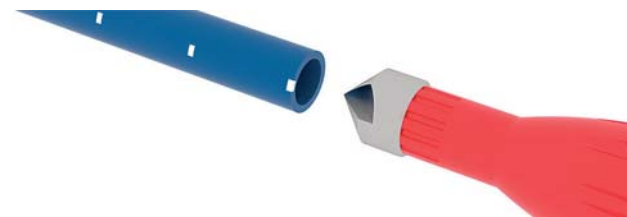

The inner edge of the pipe is slightly chamfered with a manual deburrer to a depth of approx. 1 mm.



Insert the support sleeve into the pipe as far as it will go.



The end of the pipe is slightly lubricated with 15 mm FV wide silicone grease on the O-rings.



The fitting slides onto the pipe as far as it will go. Pipe 16 is inserted 27 mm, pipe 8 is inserted 20 mm. Marks printed on the pipe are used for orientation.



After assembly, it is possible to rotate the joint and after pressing the circlip, the pipe can be extended. When reassembling, the pipe must be relubricated and inspected for damage.



Complete system for primary ground / water heat pump circuits





ENERGEO

- Distribution shafts
- Distribution cabinets
- Wall distributor
- Accessories for distribution shafts
- Fittings
- Probes
- Pipes for flat collectors made of HDPE 100 RC
- Tools
- Assembly instructions for FV ENERGEO



DISTRIBUTION SHAFTS

NEW BRADO

Waterproof shaft with integrated manifolds to distribute and collect anti-freeze liquid transferring heat between vertical or horizontal collectors and a heat pump. Can be connected to the piping by means of electrofusion fittings or mechanical couplers for HDPE.

- Inlet d50-63, outlet pipe d40
- Possibility of fitting flow meters
- Number of output circuits 2 to 10
- Walkable hatch as standard PP/GF



* for xx and yy in the cat. number, the diameter of the collector pipes and the outlet pipe is substituted

type	number of circuits	# flowmeter	# with shut off valves	collector piping Ø	outlet piping Ø	outer Ø of the shaft	shaft height[mm]	inner Ø of the shaft[mm]	weight [kg]
NEW BRADO 2	2	AA72102xxyy	AA72202xxyy	40	50	738	803	650	21
NEW BRADO 3	3	AA72103xxyy	AA72203xxyy	40	50				23
NEW BRADO 4	4	AA72104xxyy	AA72204xxyy	40	63				25
NEW BRADO 5	5	AA72105xxyy	AA72205xxyy	40	63				27
NEW BRADO 6	6	AA72106xxyy	AA72206xxyy	40	63				29
NEW BRADO 7	7	AA72107xxyy	AA72207xxyy	40	63				31
NEW BRADO 8	8	AA72108xxyy	AA72108xxyy	40	63				33
NEW BRADO 9	9	AA72109xxyy	AA72209xxyy	40	63				35
NEW BRADO 10	10*	AA72110xxyy	AA72210xxyy	40	63				37

* Other dimensions of collectors and outlet pipes on request.

ALTRA SCANDIC

Waterproof shaft with integrated manifolds to distribute and collect anti-freeze liquid transferring heat between vertical or horizontal collectors and a heat pump. Can be connected to the piping by means of electrofusion fittings or mechanical couplers for HDPE.

- Inlet d50-63, outlet pipe d40
- Number of output circuits 6 to 18
- For flat plate collectors and borehole systems
- Possibility of fitting flow meters



* for xx and yy in the cat. number, the diameter of the collector pipes and the outlet pipe is substituted

type	number of circuits	# flowmeter	# with shut off valves	collector piping Ø	outlet piping Ø	outer Ø of the shaft	shaft height[mm]	inner Ø of the shaft[mm]	weight [kg]
ALTRA SCANDIC 6	6	AA72306xxyy	AA72406xxyy	40	63	1095	896-900	909-807	51
ALTRA SCANDIC 7	7	AA72307xxyy	AA72407xxyy	40	63				53
ALTRA SCANDIC 8	8	AA72308xxyy	AA72408xxyy	40	63				55
ALTRA SCANDIC 9	9	AA72309xxyy	AA72409xxyy	40	63				57
ALTRA SCANDIC 10	10	AA72310xxyy	AA72410xxyy	40	63				59
ALTRA SCANDIC 11	11	AA72311xxyy	AA72411xxyy	40	63				61
ALTRA SCANDIC 12	12	AA72312xxyy	AA72412xxyy	40	63				63
ALTRA SCANDIC 13	13	AA72313xxyy	AA72413xxyy	40	63				65
ALTRA SCANDIC 14	14	AA72314xxyy	AA72414xxyy	40	63				67
ALTRA SCANDIC 15	15	AA72315xxyy	AA72415xxyy	40	63				69
ALTRA SCANDIC 16	16	AA72316xxyy	AA72416xxyy	40	63				71
ALTRA SCANDIC 17	17	AA72317xxyy	AA72417xxyy	40	63				73
ALTRA SCANDIC 18	18*	AA72318xxyy	AA72418xxyy	40	63				75

* Other dimensions of collectors and outlet pipes on request.

SPIDER

Waterproof shaft with integrated manifolds to distribute and collect anti-freeze liquid transferring heat between vertical or horizontal collectors and a heat pump. Can be connected to the piping by means of electrofusion fittings or mechanical couplers for HDPE.

- Inlet d75–125, outlet pipe d40
- For flat plate collectors and borehole systems
- Number of output circuits 15 to 30
- Possibility of fitting flow meters



type	number of circuits	# flowmeter	# with shut off valves	collector piping Ø	outlet piping Ø	Ø [mm]	height [mm]	weight [kg]
SPIDER 15	15	AA72715xxyy	AA72815xxyy	40	75	1000	1860	162
SPIDER 16	16	AA72716xxyy	AA72816xxyy	40	75			164
SPIDER 17	17	AA72717xxyy	AA72817xxyy	40	75			165
SPIDER 18	18	AA72718xxyy	AA72818xxyy	40	75			167
SPIDER 19	19	AA72719xxyy	AA72819xxyy	40	75			169
SPIDER 20	20	AA72720xxyy	AA72820xxyy	40	75			172
SPIDER 21	21	AA72721xxyy	AA72821xxyy	40	90			174
SPIDER 22	22	AA72722xxyy	AA72822xxyy	40	90			176
SPIDER 23	23	AA72723xxyy	AA72823xxyy	40	90			178
SPIDER 24	24	AA72724xxyy	AA72824xxyy	40	90			180
SPIDER 25	25	AA72725xxyy	AA72825xxyy	40	90			
SPIDER 26	26	AA72726xxyy	AA72826xxyy	40	110			
SPIDER 27	27	AA72727xxyy	AA72827xxyy	40	110			
SPIDER 28	28	AA72728xxyy	AA72828xxyy	40	110			
SPIDER 29	29	AA72729xxyy	AA72829xxyy	40	110			
SPIDER 30	30	AA72730xxyy	AA72830xxyy	40	110			182

* Other dimensions of collectors and outlet pipes on request.

DISTRIBUTION CABINETS

NOMO

Fully equipped wall case with manifolds to distribute and collect anti-freeze liquid transferring heat between vertical or horizontal collectors and a heat pump. Can be connected to the piping by means of electrofusion fittings or mechanical couplers for HDPE.

- Inlet d50-63, outlet pipe d40
- Possibility of fitting flow meters
- Location outside the building
- Number of output circuits 2 to 6
- Quality polyurethane thermal insulation
- Inlet DN40-63, outlet pipe DN25-40



* for xx and yy in the cat. number, the diameter of the collector pipes and the outlet pipe is substituted

type	number of circuits	flowmeter	# without flowmeters	collector piping Ø	outlet piping Ø	height [mm]	length [mm]	width [mm]	weight [kg]
NOMO 2	2	AA73102xxyy	AA73202xxyy	25-32-40	40-50-63	790	800	320	23
NOMO 3	3	AA73103xxyy	AA73203xxyy	25-32-40	40-50-63				25
NOMO 4	4	AA73104xxyy	AA73204xxyy	25-32-40	40-50-63				26
NOMO 5	5	AA73105xxyy	AA73205xxyy	25-32-40	40-50-63				27
NOMO 6	6	AA73106xxyy	AA73206xxyy	25-32-40	40-50-63				28

REGA

Fully equipped wall case with manifolds to distribute and collect anti-freeze liquid transferring heat between vertical or horizontal collectors and a heat pump. Can be connected to the piping by means of electrofusion fittings or mechanical couplers for HDPE.

- Inlet d50-63, outlet pipe d40
- Possibility of fitting flow meters
- Location outside the building
- Number of output circuits 2 to 3
- Quality polyurethane thermal insulation



* for xx and yy in the cat. number, the diameter of the collector pipes and the outlet pipe is substituted

type	number of circuits	flowmeter	# without flowmeters	collector piping Ø	outlet piping Ø	height [mm]	length [mm]	width [mm]	weight [kg]
REGA 2	2	AA73302xxyy	AA73402xxyy	25-32-40	40-50-63	430	380	180	7
REGA 3	3	AA73303xxyy	AA73403xxyy	25-32-40	40-50-63				8

WALL DISTRIBUTOR

REGO

Fully equipped wall case with manifolds to distribute and collect anti-freeze liquid transferring heat between vertical or horizontal collectors and a heat pump. Can be connected to the piping by means of electrofusion fittings or mechanical couplers for HDPE.

- Inlet d40-63, outlet pipe d40
- Possibility of fitting flow meters
- Location outside the building
- Number of output circuits 2 to 12
- Quality polyurethane thermal insulation



* for xx and yy in the cat. number, the diameter of the collector pipes and the outlet pipe is substituted

type	number of circuits	flowmeter	# without flowmeters	collector piping Ø	outlet piping Ø	height [mm]	length [mm]	width [mm]	weight [kg]
Rego 2	2	AA73502xxyy	AA73602xxyy	25-32-40	40-50-63	430	480	265	13
REGO 3	3	AA73503xxyy	AA73603xxyy	25-32-40	40-50-63				14
REGO 4	4	AA73504xxyy	AA73604xxyy	25-32-40	40-50-63				15
REGO 5	5	AA73505xxyy	AA73605xxyy	25-32-40	40-50-63				16
REGO 6	6	AA73506xxyy	AA73606xxyy	25-32-40	40-50-63				17
REGO 7	7	AA73507xxyy	AA73607xxyy	25-32-40	40-50-63				18
REGO 8	8	AA73508xxyy	AA73608xxyy	25-32-40	40-50-63				19
REGO 9	9	AA73509xxyy	AA73609xxyy	25-32-40	40-50-63				20
REGO 10	10	AA73510xxyy	AA73610xxyy	25-32-40	40-50-63				21
REGO 11	11	AA73511xxyy	AA73611xxyy	25-32-40	40-50-63				22
REGO 12	12	AA73512xxyy	AA73612xxyy	25-32-40	40-50-63				23

ACCESSORIES FOR DISTRIBUTION SHAFTS

type	unit	package	#	Ø outer [mm]	Ø inner [mm]	height [mm]
ERGA extension for shafts NEW BRADO and SPIDER	pcs	1	AA750100001			500
GEO 500 extension for shafts ALTRA and GIGA	pcs	1	AA750100002			500
BAGELAN A seal for extension GEO 500	pcs	1	AA750200001			
BAGELAN B seal for extension ERGA	pcs	1	AA750200002			
Seal for cover TUBONG	pcs	1	AA750200003			
PE shaft cover 10 kN	pcs	1	AA751100010			
PE shaft cover 10 kN with safety lock	pcs	1	AA751100011			
PE shaft cover 10 kN with insulation 200 mm	pcs	1	AA751100012			200
Seal for PE cover	pcs	1	AA751200000			
Symmetric concrete ring	pcs	1	AA751100402	1440	670	200
Asymmetric concrete ring	pcs	1	AA751100403	1440	670	200
Cast iron shaft cover with 400kN flange	pcs	1	AA751100400	820	680	115
Closing PE lid under the cast iron cover	pcs	1	AA751100401	670		

FITTINGS

Electrofusion socket SDR 11

For the system FV ENERGEO we deliver reliable electrofusion fittings with integrated brackets to 63mm diameter.

- Equipped with a barcode for electric welding readers
- Integrated holders



dimensions	unit	package	#	length [mm]
25	pcs	1	AA760000025	
32	pcs	1	AA760000032	
40	pcs	1	AA760000040	
50	pcs	1	AA760000050	
63	pcs	1	AA760000063	
90	pcs	1	AA760000090	
110	pcs	1	AA760000110	

Electrofusion blinding SDR 11

For the system FV ENERGEO we deliver reliable electrofusion fittings with integrated brackets to 63mm diameter.

- Equipped with a barcode for electric welding readers
- Integrated holders



dimensions	unit	package	#	length [mm]
25	pcs	1	AA761000025	
32	pcs	1	AA761000032	
40	pcs	1	AA761000040	
50	pcs	1	AA761000050	
63	pcs	1	AA761000063	

Electrofusion reduction of SDR 11

For the system FV ENERGEO we deliver reliable electrofusion fittings with integrated brackets to 63mm diameter.

- Equipped with a barcode for electric welding readers
- Integrated holders



dimensions	unit	package	#	length [mm]
40-32	pcs	1	AA762040032	
32-25	pcs	1	AA762032025	

Electrofusion bend 90° SDR 11

For the system FV ENERGEO we deliver reliable electrofusion fittings with integrated brackets to 110mm diameter.



- Equipped with a barcode for electric welding readers
- Integrated holders

dimensions	unit	package	#			
25	pcs	1	AA763000025			
32	pcs	1	AA763000032			
40	pcs	1	AA763000040			
50	pcs	1	AA763000050			
63	pcs	1	AA763000063			
90	pcs	1	AA763000090			
110	pcs	1	AA763000110			

Insert transition PE - brass female thread SDR 11

For the system FV ENERGEO we deliver reliable electrofusion fittings with integrated brackets to 63mm diameter.



- Equipped with a barcode for electric welding readers
- Integrated holders

dimensions	unit	package	#			
32-1"	pcs	1	AA764032010			
40-1 1/4"	pcs	1	AA764040054			
50-1 1/2"	pcs	1	AA764050064			
63-1"	pcs	1	AA764063010			
63-1 1/4"	pcs	1	AA764063054			
63-1 1/2"	pcs	1	AA764063064			
63-2"	pcs	1	AA764063020			

Insert transition PE - brass male thread SDR 11

For the system FV ENERGEO we deliver reliable electrofusion fittings with integrated brackets to 63mm diameter.



- Equipped with a barcode for electric welding readers
- Integrated holders

dimensions	unit	package	#			
25-3/4"	pcs	1	AA765025034			
32-1"	pcs	1	AA765032010			
32-1 1/4"	pcs	1	AA765032054			
32-1 1/2"	pcs	1	AA765032064			
40-1"	pcs	1	AA765040010			
40-1 1/4"	pcs	1	AA765040054			
40-1 1/2"	pcs	1	AA765040064			
50-1"	pcs	1	AA765050010			
50-1 1/4"	pcs	1	AA765050054			
50-1 1/2"	pcs	1	AA765050064			
63-1 1/4"	pcs	1	AA765063054			
63-1 1/2"	pcs	1	AA765063064			
63-2"	pcs	1	AA765063020			

Insert transition PE - brass with nut SDR 11

For the system FV ENERGEO we deliver reliable electrofusion fittings with integrated brackets to 63mm diameter.

- Equipped with a barcode for electric welding readers



dimensions	unit	package	#			
25-3/4"	pcs	1	AA766025034			
32-1"	pcs	1	AA766032010			
40-1 1/4"	pcs	1	AA766040054			
50-1 1/2"	pcs	1	AA766050064			
63-1"	pcs	1	AA766063010			
63-1 1/2"	pcs	1	AA766063064			
63-2"	pcs	1	AA766063020			

Electrofusion Y-piece - reducing the number of branches

For the system FV ENERGEO we deliver reliable electrofusion fittings with integrated brackets to 50mm diameter.

- Equipped with a barcode for electric welding readers
- Integrated holders



dimensions	unit	package	#	d1 [mm]	d2 [mm]	length [mm]
32/32-40 direct	pcs	1	AA767032040	32	40	236
40/40-50 direct	pcs	1	AA767040050	40	50	255
32/32-40 90°	pcs	1	AA767103240	32	40	245
40/40-50 90°	pcs	1	AA767104050	40	50	270

PROBES

FV ENERGEO GH 12,5

Single-circuit vertical collectors designed to draw heat from geothermal boreholes to supply all types of soil/water heat pumps.

- d 40 × 3.7 ad 32 × 3.0 mm, l 60-150 m
- Full brightness throughout the probe profile
- Lifespan of more than 100 years
- Head with perfect factory welding
- Increased resistance to crack expansion
- Certified



type	unit	weight [kg]	Ø of coil [mm]	coil height [mm]	#	D [mm]	length [m]
2 × 32 × 60	pcs	28	1 148	256	AA700123060	32	60
2 × 32 × 70	pcs	32	1 212	256	AA700123070	32	70
2 × 32 × 80	pcs	37	1 148	320	AA700123080	32	80
2 × 32 × 90	pcs	41	1 148	320	AA700123090	32	90
2 × 32 × 100	pcs	46	1 212	320	AA700123100	32	100
2 × 32 × 110	pcs	51	1 212	384	AA700123110	32	110
2 × 32 × 120	pcs	55	1 212	384	AA700123120	32	120
2 × 32 × 130	pcs	60	1 276	384	AA700123130	32	130
2 × 32 × 140	pcs	64	1 276	384	AA700123140	32	140
2 × 32 × 150	pcs	69	1 340	384	AA700123150	32	150
2 × 40 × 60	pcs	42	1 180	320	AA700124060	40	60
2 × 40 × 70	pcs	49	1 180	400	AA700124070	40	70
2 × 40 × 80	pcs	56	1 180	400	AA700124080	40	80
2 × 40 × 90	pcs	63	1 260	400	AA700124090	40	90
2 × 40 × 100	pcs	70	1 340	400	AA700124100	40	100
2 × 40 × 110	pcs	77	1 340	400	AA700124110	40	110
2 × 40 × 120	pcs	84	1 420	400	AA700124120	40	120
2 × 40 × 130	pcs	91	1 500	400	AA700124130	40	130
2 × 40 × 140	pcs	98	1 500	400	AA700124140	40	140
2 × 40 × 150	pcs	105	1 500	480	AA700124150	40	150

FV ENERGEO GH 16

Single-circuit vertical collectors designed to draw heat from geothermal boreholes to supply all types of soil/water heat pumps.



- d 40 × 3.7 ad 32 × 3.0 mm, l 130–220 m
- Full brightness throughout the probe profile
- Lifespan of more than 100 years
- Head with perfect factory welding
- Increased resistance to crack expansion
- Certified

type	unit	weight [kg]	coil Ø [mm]	coil height [mm]	#	D [mm]	length [m]
2 × 32 × 130	pcs	73	1276	384	AA700163130	32	130
2 × 32 × 140	pcs	78	1276	384	AA700163140	32	140
2 × 32 × 150	pcs	84	1340	384	AA700163150	32	150
2 × 32 × 160	pcs	90	1404	384	AA700163160	32	160
2 × 40 × 130	pcs	109	1500	400	AA700164130	40	130
2 × 40 × 140	pcs	118	1500	400	AA700164140	40	140
2 × 40 × 150	pcs	126	1500	480	AA700164150	40	150
2 × 40 × 160	pcs	134	1500	480	AA700164160	40	160
2 × 40 × 170	pcs	143	1580	480	AA700164170	40	170
2 × 40 × 180	pcs	151	1580	480	AA700164180	40	180
2 × 40 × 190	pcs	160	1660	480	AA700164190	40	190
2 × 40 × 200	pcs	168	1660	480	AA700164200	40	200
2 × 40 × 210	pcs	176	1580	560	AA700164210	40	210
2 × 40 × 220	pcs	185	1660	560	AA700164220	40	220

FV ENERGEO GH DUO 12,5

Double-circuit vertical collectors designed to draw heat from geothermal boreholes to supply all types of soil/water heat pumps.



- d 32 × 3.0 mm, l 60–130 m
- Full brightness throughout the probe profile
- Lifespan of more than 100 years
- Head with perfect factory welding
- Increased resistance to crack expansion
- Certified

type	unit	weight [kg]	coil Ø [mm]	coil height [mm]	#	D [mm]	length [m]
4 × 32 × 60	pcs	55	1212	384	AA701123060	32	60
4 × 32 × 70	pcs	64	1276	384	AA701123070	32	70
4 × 32 × 80	pcs	74	1212	512	AA701123080	32	80
4 × 32 × 90	pcs	83	1276	512	AA701123090	32	90
4 × 32 × 100	pcs	92	1212	640	AA701123100	32	100
4 × 32 × 110	pcs	101	1276	640	AA701123110	32	110
4 × 32 × 120	pcs	110	1340	640	AA701123120	32	120
4 × 32 × 130	pcs	120	1340	640	AA701123130	32	130

FV ENERGEO GH DUO 16

Double-circuit vertical collectors designed to draw heat from geothermal boreholes to supply all types of soil/water heat pumps.



- d 32 × 3.0 mm, l 120–150 m
- Full brightness throughout the probe profile
- Lifespan of more than 100 years
- Head with perfect factory welding
- Increased resistance to crack expansion
- Certified

type	unit	weight [kg]	coil Ø [mm]	coil height [mm]	#	D [mm]	length [m]
4 × 32 × 120	pcs	134	1340	640	AA701163120	32	120
4 × 32 × 130	pcs	146	1340	640	AA701163130	32	130
4 × 32 × 140	pcs	157	1276	768	AA701163140	32	140
4 × 32 × 150	pcs	168	1340	768	AA701163150	32	150

PIPES FOR FLAT COLLECTORS MADE OF HDPE 100 RC

FV ENERGEO CP HDPE 100RC PN 10

High-quality HDPE RC pipes for construction of horizontal collectors of heat pumps ground/water. They are produced of the latest technology under permanent control of the top HDPE 100-RC polymer which ensures long-lasting perfect functionality of the system.

- Reliability and safety, service life > 100 years
- Low installation costs
- Allows more demanding laying conditions
- Increased handling resistance, quality of welds
- Long-term pressure resistance even when the surface is damaged



type	unit	weight [kg]	coil Ø [mm]	coil height [mm]	#	D [mm]	length [m]
32 × 2,0 × 100	pcs	19	1150	192	AA710103100	32	100
32 × 2,0 × 150	pcs	29	1150	288	AA710103150	32	150
32 × 2,0 × 200	pcs	38	1150	384	AA710103200	32	200
40 × 2,4 × 100	pcs	28	1180	280	AA710104100	40	100
40 × 2,4 × 150	pcs	42	1180	440	AA710104150	40	150
40 × 2,4 × 200	pcs	56	1260	480	AA710104200	40	200

FV ENERGEO CP HDPE 100RC PN 12,5

High-quality HDPE RC pipes for construction of horizontal collectors of heat pumps ground/water. They are produced of the latest technology under permanent control of the top HDPE 100-RC polymer which ensures long-lasting perfect functionality of the system.

- Reliability and safety, service life > 100 years
- Low installation costs
- Allows more demanding laying conditions
- Increased handling resistance, quality of welds
- Long-term pressure resistance even when the surface is damaged



type	unit	weight [kg]	coil Ø [mm]	coil height [mm]	#	D [mm]	length [m]
32 × 2,4 × 100	pcs	23	1150	192	AA710123100	32	100
32 × 2,4 × 150	pcs	35	1150	288	AA710123150	32	150
32 × 2,4 × 200	pcs	46	1150	384	AA710123200	32	200
40 × 3,0 × 100	pcs	35	1180	280	AA710124100	40	100
40 × 3,0 × 150	pcs	53	1180	440	AA710124150	40	150
40 × 3,0 × 200	pcs	70	1260	480	AA710124200	40	200

FV ENERGEO CP HDPE 100RC PN 16

High-quality HDPE RC pipes for construction of horizontal collectors of heat pumps ground/water. They are produced of the latest technology under permanent control of the top HDPE 100-RC polymer which ensures long-lasting perfect functionality of the system.

- Reliability and safety, service life > 100 years
- Low installation costs
- Allows more demanding laying conditions
- Increased handling resistance, quality of welds
- Long-term pressure resistance even when the surface is damaged



type	unit	weight [kg]	coil Ø [mm]	coil height [mm]	#	D [mm]	length [m]
32 × 3,0 × 100	pcs	28	1150	192	AA710163100	32	100
32 × 3,0 × 150	pcs	42	1150	288	AA710163150	32	150
32 × 3,0 × 200	pcs	56	1150	384	AA710163200	32	200
40 × 3,7 × 100	pcs	42	1180	280	AA710164100	40	100
40 × 3,7 × 150	pcs	63	1180	440	AA710164150	40	150
40 × 3,7 × 200	pcs	84	1260	480	AA710164200	40	200

TOOLS

Electrofusion welder with barcode reader

For fast and easy automatic welding with electrofusion fittings using a bar code.



				#
SVEL 3500-3800 W for d20-d300 mm	pcs	1	26,0	AA401102000
SVEL 3500 PLUS 3800 W for d20-d300 mm with integrated list and direct printing welding Protocol	pcs	1	26,0	AA401104000

Weight



				#
FV GS 32 13	pcs	1	13	AA709032013
FV GS 32 26	pcs	1	26	AA709032026
FV GS 40 13	pcs	1	13	AA709040013
FV GS 40 26	pcs	1	26	AA709040026

ASSEMBLY INSTRUCTIONS FOR FV ENERGEO

FV ENERGEO is a comprehensive system of key elements for the use of geothermal energy through deep drilling and surface ground collectors. Geothermal energy is one of the most ecological and practically inexhaustible sources of heat and thus represents an attractive solution with an interesting return.

Design and installation of geothermal systems with heat pumps can be performed exclusively by authorized persons and companies. Drilling of deep wells is dealt with by special legal regulations for mining works, and the permitting of wells in most countries is subject to the Mining Authority.

AREA COLLECTORS

The ground collector system is the most efficient choice when considering the type of heat pump installation. Acquisition costs are comparable to an air-water system, the advantage is higher efficiency (COP) and longer compressor life.

In the case of flat plate collectors, energy is obtained by means of pipes laid horizontally in the ground, usually in a 1.2-1.5 m deep excavation or in a groove excavated by a groove. Pipes d32 to d40 are usually used for collectors, exceptionally d25.

An antifreeze heat transfer fluid (alcohol, glycerin, glycol) diluted with water to the required antifreeze system circulates in the system. In the heat pump, it delivers its coolant temperature, which it then obtains by heating in the ground. The ground temperature is affected by external conditions (rain, snow, wind) at depths of up to 5 m and also varies depending on the season.

No further construction can be carried out at the collector installation site after installation.

Depending on the nature of the subsoil, flat plate collectors must be made of FV ENERGEO HDPE 100 RC pipes in pressure series PN10, PN12.5 and PN16. This material allows laying without a sand bed and upper backfilling with directly excavated material, including aggregates up to 200 mm.

Subsoil	Specific consumption	
	at 1800 h	at 2400h
Dry soil	10 W/m ²	8 W/m ²
Cohesive soil, moist	20-30 W/m ²	16-24 W/m ²
Waterlogged sand / gravel	40 W/m ²	32 W/m ²

CONNECTION

Electrical fittings, exceptionally mechanical clamps, are mainly used to connect individual pipes. When using electric fittings, an absolutely tight homogeneous connection is created, which is why we use high-quality Georg Fisher electric fittings in the FV ENERGEO system.

The work must be carried out by personnel who have a welding license for welding plastics.

Polyethylene cannot be welded with polypropylene; however, we also draw attention to the impossibility of mutual welding of pipes and fittings made of branched (LDPE, rPE) and linear polyethylene. The weldment of these relatively difficult-to-distinguish materials (LDPE has a greater wall thickness for the same pressure) can by no means be used in practice.

If it is necessary to connect both materials, in case of your doubts about the origin of the individual PE pipes to be connected, use mechanical couplings instead.

BACKBONE MANAGEMENT

The manifold / collector is connected to the heat pump via a backbone line. The backbone line consists of a larger diameter polyethylene pipe FV ENERGEO HDPE or FV ENERGEO HDPE-RC. The diameter of the pipe is determined depending on its length and the flow of heat transfer antifreeze.

The backbone lines made of HDPE pipes must be laid in a protective sand bed.

PRIMARY CIRCUIT INSULATION

All types of pipes, whether they are backbone lines or pipes leading directly from boreholes or surface collectors, it is necessary to start insulating 2m from the building. It is also necessary to insulate all pipes within the building so that there is no possible condensation of water on the distribution lines. It is possible to insulate the primary circuit only with a suitable rubber insulation, not with insulation from PE materials, etc. Pipes insulated with rubber insulation outside the building must be protected with a protector and provided with a seal against the ingress of water into the protector.

Principles of correct installation of ground collectors:

- Correct dimensioning - the most important protection against collector freezing
- Slope for easy venting at the highest point
- Adherence to safe pipe spacing - at least 60-100 cm depending on the diameter of the pipe used, optimally 1 m
- Laying of collectors at least 0.7-1 m from the water supply / sewerage system, in case of crossing with pipe insulation engineering networks

GEOTHERMAL DRILLS

In geothermal wells, energy is obtained using geothermal earth probes. It is a closed system, where boreholes with a depth of about 70 m to 300 m are equipped with FV ENERGEO HDPE-RC pipes. At the end of the pipe, there is a return U elbow. Two basic ways of dressing are used:

- Single-circuit probes with 2 × 25, 2 × 32 or 2 × 40mm pipes
- Two-circuit probes with 4 × 32mm piping.

The most often drill depth is 150m. The temperature at a depth of 20 m below the surface is about 10 °C and increases every 30 m by 1 °C - it is not affected by the current weather or the outside temperature on the surface, however, it differs at the beginning and end of the heating season. At a depth of 150 m, the temperature is practically constant at about 15 °C, sufficient for the required heat gain. At greater depths, the higher heat gain is offset by a significant increase in installation costs (drilling and equipment). An antifreeze mixture (alcohol, glycerin, glycol) circulates in the system, which is diluted with water to the required antifreeze.

When dimensioning the depth of boreholes, we recommend taking into account a profitability of up to 50 W / m for heating and a load of approx. 2 400 hours per year for heating, including DHW heating. The profitability of the rock fragment should be verified by a special test.

Subsoil	at 1800 h	at 2400h
	Bad subsoil (dry sediment) - (λNormal solid rock and aquifer - (λ=1,5-3,0 W/(m·K))	60 W/m
Solid rock with high thermal conductivity - (λ>m·3,0 W/(m·K))	84 W/m	70 W/m
Individual rocks		
Sand, gravel, dry sand, gravel, leading water	65-80 W/m	55-65 W/m
In case of strong underground water flow in sand or gravel, individual devices	80-100 W/m	80-100 W/m
Clay, wet	35-50 W/m	30-40 W/m
Limestone massif	55-70 W/m	45-60 W/m
Sandstone	65-80 W/m	55-65 W/m
Acid igneous rock (eg granite)	65-85 W/m	55-70 W/m
Acid igneous rock (eg basalt)	40-65 W/m	35-55 W/m
Gneiss	70-85 W/m	60-70 W/m

The values may fluctuate depending on the rock structure (cracking, shale, weathering).

REDUCTION OF THE NUMBER OF BRANCHES (Y PIECE)

The Y piece is a special fitting for combining two-circuit geothermal earth probes into one circuit (32-32-40 or 40-40-50). Their use reduces the number of connecting pipes leading from the boreholes to the manifold / collector system as well as the number of outlets of the manifold / collector itself. The Y-piece CANNOT be replaced by a classic T-piece to prevent significant pressure loss in the entire system! When using a reduction, it is necessary to maintain an even distribution of fluid flow in both loops of the geothermal well.

Principles of proper implementation of geothermal wells

- Correct dimensioning of the depth and number of boreholes (with correct dimensioning, the borehole cannot freeze)
- Adherence to safe distances between geothermal wells depending on the depth of the borehole - about 10% of the total length of the borehole is recommended
- Use of FV ENERGEO HDPE-RC probes
- Use the services of certified drilling companies (drilling work required with permission from the relevant authorities)
- Adhere to the basic conditions and do not endanger the existing systems of drilled / dug wells in the area (injection of wells - insulation of individual gutters)

Before the project itself, it is necessary to find out whether it is possible to drill on the plot and, if so, to what depth (in the PLA, the area around the mine shafts, the protection zone of the London metro)

LAYING IN A SAND BED

Laying in an open excavation, where sand is used for upper and lower backfilling the pipeline, is one of the oldest methods of laying PE pipelines. If older types of PE pipes (PE 63, PE 80 and PE 100), which do not have increased resistance to mechanical stress, were not placed in a sand bed, their expected service life would be reduced by more than five times. Thanks to the sand upper and lower backfill that protects the pipes, this method of laying is one of the low-risk laying.

LAYING

For HDPE-RC pipes, its laying and upper backfilling can be carried out without a sand bed directly using the excavated soil, including aggregates up to 200 mm.

For HDPE pipes, the nature of the subsoil must be respected. If the pipeline route is located in areas where the soils are of extraction class I. to IV. (according to ČSN 73 6133: 2010), we can also use directly excavated soil for laying. The exact definition of the extractability class can only be determined by geological survey, which is usually part of the preparation of each project. Earthworks during the laying of the pipeline must not affect its ovality. The upper and lower backfill material must be sufficiently compactable. The pipe is laid on the level and paved bottom of the groove. The backfill is carried out in layers and metallurgical.

If the pipeline route is located in areas where soils of mining class V to VII occur. or the occurrence of soils of mining class V. to VII. cannot be refuted, the pipes must be properly laid in a sand bed.

CONNECTION

Electrical fittings, exceptionally mechanical clamps, are mainly used to connect individual pipes. When using electric fittings, an absolutely tight homogeneous connection is created, which is why we use high-quality Georg Fisher electric fittings in the FV ENERGEO system.

WELDING

For the connection of FV ENERGEO HDPE and HDPE-RC pipes with fittings, butt-welding, polyfusion or electric fitting can be used, which we recommend for the FV ENERGEO system. In addition to the smooth creation of the connection directly in the field, the electrical fittings also enable the assembly of the entire piping system thanks to the integrated clamps.

The work must be carried out by personnel who have a welding license for welding plastics.

It is not permissible to weld polyethylene with polypropylene and to weld pipes and fittings made of branched (LDPE, PE) and linear (HDPE, HDPE-RC) polyethylene. If both materials need to be joined, mechanical couplings must be used.

The most important operations for achieving a quality weld are:

- cleaning of pipe ends and possibly also fittings from mechanical impurities
- perpendicular cutting (planing) of the pipe ends so that the maximum distance when the pipes are chamfered is 0.5 mm.
- check the mutual offset of the pipes, which must not exceed 1/10 of the wall thickness (pay attention to pipes of different pressure series!)

- for polyfusion and electric welding: removal of the oxidized plastic layer with subsequent cleaning with a suitable degreasing and cleaning agent, cleaning is performed just before welding and the cleaned surfaces must not be contaminated even by hand
- The place where butt welding or polyfusion welding is performed should be protected from weather conditions.

Caution when welding at low temperatures - the permissible minimum temperatures at which welding is still possible are given by the properties of the welders or electric fittings. In strong winds, in addition to checking the correct setting of the temperatures of the welding jigs, it is necessary to check the actual temperatures of the jig during butt welding or polyfusion welding. The welding temperature for PE butt welding is 200 to 220 ° C, for polyfusion welding it is in the range of 250 - 270 ° C. It is important to adhere to the time course of individual operations, including the cooling time, during which the weld cannot be mechanically loaded. In this context, we refer to the instructions of the manufacturers of individual welding machines and, above all, to the mandatory training.

MECHANICAL CONNECTION

Mechanical clamps allow the connection of combinations of different materials and the possibility of using even slightly oval pipes that the fittings are able to form. Couplings can be metal or plastic. A properly made connection has the same or higher tensile strength than the joined pipe itself. Joining with the help of flanges (flange collars) can also be included in this group.

PIPE HANDLING, MECHANICAL STRESS AND CHANGE OF PIPE DIRECTION (BENDING)

It is not allowed to perform hot forming of pipes on the construction site. However, the flexibility of PE allows you to change direction or copy the terrain by creating arcs of radius R, for which, depending on the temperature, applies (independent of the pressure line of the pipe):

- 20 °C20 × D
- 10 °C35 × D
- 0 °C50 × D

where D is the outer diameter of the pipe. Properly executed excavation can therefore mean material and time savings.

Appropriate fittings must be used for larger changes of direction.

Coils with pipes must be protected against mechanical damage. In case of visible damage to the upper layer (its cutting or abrasion), it is necessary to cut out the relevant part of the pipe and connect the ends with a suitable fitting.

Pipes can only be unwound in the opposite way to what they were wound during production. It is forbidden to unwind in a spiral, when the wall of the pipe is torsionally stressed, and when there is a risk of "breaking" the pipe !!

Fittings and cast iron fittings must be installed in such a way that their weight or the force required for their operation does not stress the pipes with forces that were not taken into account during the design. It is recommended to fix the fittings with a "fixed point" - ie using a concrete block etc

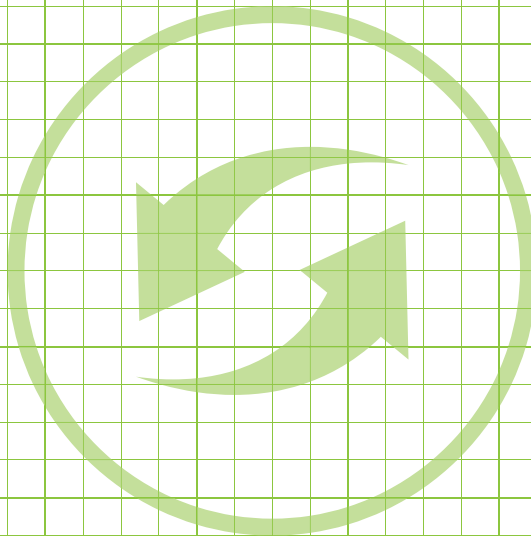

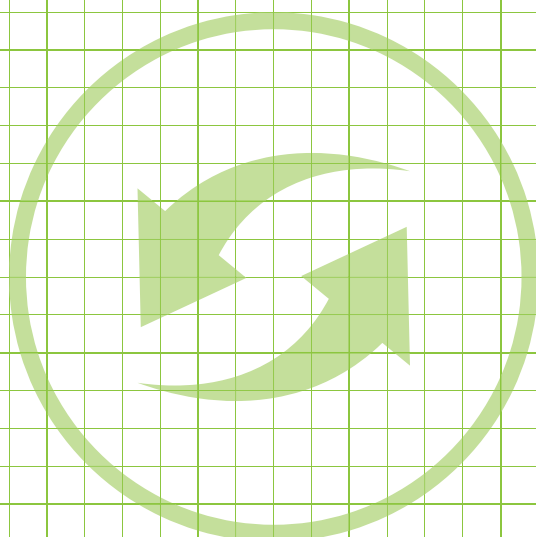



Highly durable quality HDPE RC pipes for infrastructural water distribution





INFRA

- FV INFRA pipes
- Assembly instructions for FV INFRA



FV INFRA PIPES

FV HDPE 100 RC SDR 11

System: **INFRA**
 Material: HDPE
 Standard: ČSN EN 12201-2
 Note: Length 12m on request

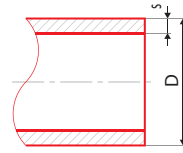

						#	D [mm]	s [mm]	SDR	l [m]
25 × 2,3	m			0,17	0,73	AA162025100	25	2,3	11	100
32 × 3,0	m			0,27	1,10	AA162032100	32	3,0	11	100
40 × 3,7	m			0,43	1,83	AA162040100	40	3,7	11	100
50 × 4,6	m			0,67	2,75	AA162050100	50	4,6	11	100
63 × 5,8	m			1,05	4,07	AA162063100	63	5,8	11	100
25 × 2,3	m			0,17	0,73	AA162025006	25	2,3	11	6
32 × 3,0	m			0,27	1,10	AA162032006	32	3,0	11	6
40 × 3,7	m			0,43	1,83	AA162040006	40	3,7	11	6
50 × 4,6	m			0,67	2,75	AA162050006	50	4,6	11	6
63 × 5,8	m			1,05	4,07	AA162063006	63	5,8	11	6

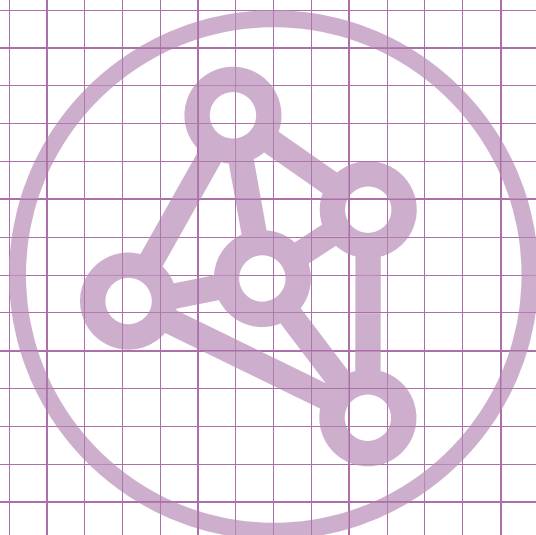

ASSEMBLY INSTRUCTIONS FOR FV INFRA

FV HDPE 100 pipes and HDPE 100 RC pipes (Resistant to Cut, ie resistant to damage and crack propagation) are intended for infrastructural distribution of water or other media. They are made of so-called linear high-density polyethylene (called HDPE, PEHD or I-PE).

The strength of MRS for HDPE 100 is thus 10 MPa 2.5 times higher than for the currently commonly used low-density branched polyethylene (LDPE). For a given pressure, the wall thickness and hydraulic parameters were significantly reduced. HDPE 100 also has higher damage resistance and better chemical resistance and is better in a number of other properties.

HDPE 100 RC pipes are characterized by increased toughness, resistance to damage by point loads and crack propagation and are suitable for laying under extreme conditions.

AREA OF APPLICATION FV HDPE PIPES

FV HDPE 100 and FV HDPE 100 RC pressure pipes can be used:

- for the transport of potable and utility water
- for the transport of common refrigerant and antifreeze mixtures
- for the transport of certain aqueous suspensions
- for the transport of certain chemicals
- to transport air and other gases
- for hydraulic transport of abrasive materials
- for primary circuits and heat pump exchangers
- for snowmaking equipment (snow cannons)
- for the construction of pressure and vacuum sewer lines

Liquid and bulk substances can be transported as long as there is no risk of electrostatic charge. HDPE pipes are resistant to common chemicals, but are not recommended for the transport of potable water in soils heavily contaminated with organic substances

LAYING

Laying method	FV HDPE 100	FV HDPE 100 RC
Laying in the excavation "sand"	without risks	without risks
Laying in the excavation, grain up to 200 mm	inappropriate	moderate risk
Relining pipes with a smooth inner surface	without risks	without risks
Relining tubes inside unspecified	inappropriate	moderate risk
Plowing	inappropriate	moderate risk
Milling	inappropriate	moderate risk
Controlled sub-holes *	inappropriate	moderate risk

When laying, it is necessary to comply with the requirements of ČSN EN 805 regarding distances from structures and cables and protective zones.

Pipes for the transport of potable water are generally laid to a non-freezing depth according to ČSN 73 6005:

- In the sidewalk and in open terrain outside the built-up area at least 1.00 to 1.60 m (depending on the type and properties of the soil).
- In the road min. 1.5m.

For shallow deposits, it is necessary to take measures against freezing of the water supply by insulation or heating.

The anchoring of the pipeline needs to be solved at a longitudinal slope of over 15%, depending on the geological conditions.

Longitudinal expansion joints of pipes are not necessary when laying in the ground. Expansion compensation, on the other hand, is necessary in the case of pipelines above ground and in buildings, due to the high coefficient of thermal expansion (0.2 mm / mK).

Sufficient attention must be paid to the excavation and laying of the pipeline. The width of the excavation must allow safe handling of the pipe, including its connection and sufficient compaction of the soil around the pipe, according to the conditions and purpose of use.

The excavation width depends on the pipe diameter and the required excavation depth.

MINIMUM EXCAVATION WIDTH ACCORDING TO PIPE DIAMETER:

d [mm]	minimum excavation width D + x [m]		
	excavation with sheeting	with excavation without sheeting	
		$\beta > 60^\circ$	$\beta \leq 60^\circ$
≤ 225	D + 0,40	D + 0,40	D + 0,40
> 225 to ≤ 350	D + 0,50	D + 0,50	D + 0,40
> 350 to ≤ 700	D + 0,70	D + 0,70	D + 0,40

d - outer diameter of the pipe in mm, D - outer diameter of the pipe in m, β - angle of the unheated wall of the excavation. The smallest working distance between the pipe wall and the excavation wall (sheeting) is x / 2

MINIMUM EXCAVATION WIDTH ACCORDING TO EXCAVATION DEPTH

Groove depth [m]	Minimum width [m]
> 1,00	is not prescribed
$\geq 1,00$ to $\leq 1,75$	0,80.
> 1,75 to $\leq 4,00$	0,90.
> 4,00	1,00

The soil under the pipe and up to 15 cm above the upper edge of the pipe is considered to be the effective layer when laying the pipe (see schematic sections of the installation). The embankment and compaction is carried out in layers, always on both sides of the pipe. For pipes with a diameter of 110 mm and up, metallurgy is done by hand or light compaction technique. Directly above the pipe, it does not compact up to a height of 30 cm. During compaction, the pipe must not move in height or sideways.

PE 100RC pipes can be used for so-called "sand-free laying" in most common excavations and covered directly with excavated material, up to 50% of the aggregate admixture up to 250 mm in size.

PE100 pipes are laid in a trench on a sand or gravel bed (upper backfill) with a minimum thickness of L = 10 cm. The soil does not have to be compacted, but it must not be too loose. For HDPE 100 pipes and fittings, backfilling in the effective layer is basically done with sand or soil without sharp-edged particles.

Pipes must not be laid on frozen ground. It must lie on the ground along its entire length, without point joints on the rock protrusions or on the necks - assembly holes are created for mechanical fittings or electrical fittings. The laying angle, ie contact with the bed, should be greater than 90°.

In the rocky and stony subsoil, a new sand or gravel bed must be created for the pipes (except for RC pipes) after removing an approx. 15 cm layer, leveled to the correct slope and compacted as required.

Sand is used for all types of pipes, unless otherwise specified by the supplier of the fitting. The backfill should exceed the fitting by min. 20 cm on each side.

Pipes CANNOT be laid directly on concrete or other solid surfaces; if, for example, concrete slabs are used in unbearably soils, a 15 cm sand or gravel bed must be created on them.

PIPE LOWER AND UPPER BACKFILL

The soil corresponding to the specification for the active layer and the type of pipe is used. Pour from a reasonable height to prevent damage or movement of the piping. There must be no cavities in the vicinity of the pipe, therefore materials that may change in volume or consistency over time cannot be used for backfilling (eg soil containing pieces of wood, ice, organic or soluble materials).

Water pipes must not pass through soil contaminated with organic substances. Such soil cannot be used in backfills. In principle, an excavation unsuitable for upper backfilling must be replaced with suitable soil.

According to ČSN 73 6006 (8/2003), it is appropriate to mark the pipeline with a warning foil placed at least 20 cm above the top of the pipe:

The material and method of compaction that corresponds to the use of the given area is used for the upper backfill of the pipeline. From 30 cm coverage, it can also be compacted above the pipe.

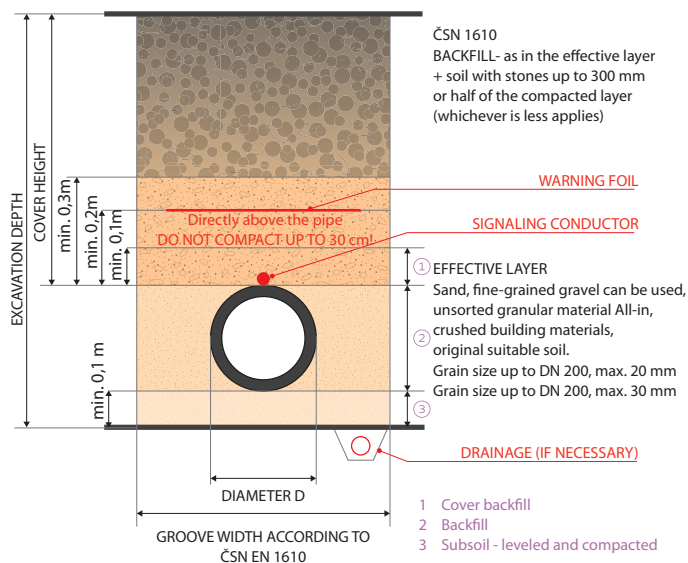

Scheme of laying FV HDPE 100 pipes in the excavation

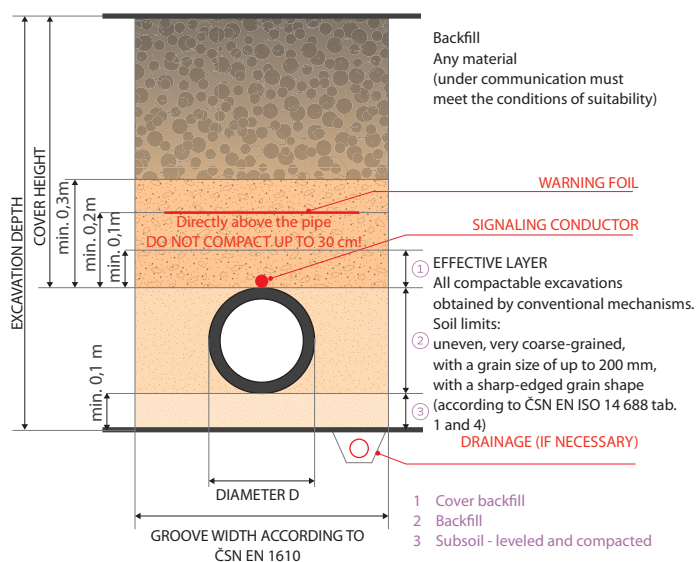

Scheme of laying FV HDPE 100 RC pipes in the excavation

CONNECTION

PE pipes and fittings are connected by welding or mechanically (metal or plastic compression fittings, flange connections using a welded flange collar).

GLUING POLYETHYLENE PIPES IS NOT PERMITTED!

The advantage of clamping is the possibility of combining various SDRs or different materials. Clamping couplings can be made of metal or plastic, a detachable design can be more favorable. A properly made connection has the same or higher tensile strength than the joined pipe itself.

Follow the fittings manufacturer's instructions when joining. The cleanliness of the components is very important. For the correct connection, it is necessary to mark the insertion depth (marker, pencil). If the pipe is inserted just a little, the joint may have high tensile strength, but may not seal.

WELDING

HDPE pipes and fittings can be butt welded or electric welded, polyfusion welding (pipe welding) is exceptionally used.

Mutual welding of pipes and fittings made of HDPE100 and HDPE 100 RC is not limited. Polyethylene cannot be welded with polypropylene.

It is also not possible to weld pipes or fittings made of linear (HDPE, IPE, PE80, PE100) and branched polyethylene (LDPE, rPE, PE40). Use only mechanical couplings to connect non-weldable HDPE and LDPE pipes.

PIPE BENDING / PIPE DIRECTION CHANGE

Appropriate fittings are used to change the direction. It is not allowed to perform hot forming of pipes on the construction site. The high flexibility of HDPE allows you to change direction or copy the terrain by creating arcs of radius R. The bending radius depends on the pipe diameter and temperature, it does not depend on the pressure class of the pipe.

PERMITTED BENDING RADIUS

Temperature	20 °C	10 °C	0 °C
Arc radius R	20 × D	35 × D	50 × D

where D is the outer diameter of the pipe.

By suitable use of arches during excavation work, the consumption of fittings and pipes can be saved, therefore it is necessary to pay attention to it already during the design of the excavation.

TRANSPORT, STORAGE AND MANIPULATION

- During transport and storage, the pipes must lie on the substrate along their entire length to prevent them from sagging. The loading area of vehicles must be without sharp protrusions and the base must not be rocky during storage. Supported beams should not be narrower than 50 mm.
- For pipes in rods, it is necessary to prevent bends at the edges and vibrations of the free ends of the pipes. The ends of the pipes exceeding the loading area of the vehicle by more than 1 m must therefore be supported.
- Pipes must not be dropped or pulled over sharp gravel or rough ground during loading and unloading.
- The maximum storage height of pipes unpacked from pallets is 1.6 m, while the side supports should not be more than 3 m apart.
- Prolonged storage of pipes in direct sunlight can cause discoloration.
- HDPE pipes can be stored and handled even in winter up to -20 °C, but it is necessary to observe the prescribed temperatures for welding and other operations.
- The products must be protected against contact with solvents and contamination with toxic substances.
- The protective caps can only be removed from the pipes and fittings just before use.
- The pipes in the coils are stored upright, secured against falling or horizontally up to a height of 1.6 m. The coil must not be loaded against the ends of the pipes when stored upright.
- before unrolling, remove the tape securing the outer end of the pipe and then gradually release the other layers, we recommend releasing only as much pipe as is currently needed
- An unwinding device (trolley) is recommended for unpacking the coils, a slow-moving vehicle can also be used.
- It is inadmissible to unwind the pipe in a spiral - there is a risk of "breaking" the pipe.
- When unwinding or straightening, especially at lower temperatures, the pipes must not be subjected to excessive bending.
- We recommend adding a leveling device to the unwinding trolley.

PERMITTED DAMAGE TO PIPES WHEN USED FOR PRESSURE APPLICATIONS

Maximum depth of pipe wall damage:

- FV HDPE 100** - only permissible backfill: max. 10% of the wall thickness
- FV HDPE 100 RC** - sand filling: max. 15% of the wall thickness
- FV HDPE 100 RC** - other backfill: max. 10%

alca GROUP



Made in Czech Republic

- 2020 ESTABLISHMENT OF THE HOLDING
- 3 companies in the holding
- 100 % CZECH CAPITAL
- 1000 Employees
- 120 Millions of euros
- >70 COUNTRIES ACROSS THE WORLD USE OUR PRODUCTS
- 11 FOREIGN BRANCHES
- 3 PRODUCTION PLANTS
- 72 000 m² production area
- Own production of products and components ☒
- Independence subcontracting



COMPLETE RANGE OF SANITARY ENGINEERING AND PIPING SYSTEMS

alcadrain

Sanitary systems

Alcadrain was founded in 1998 as a family-owned Czech company under the name Alcaplast, and in 2022 it changed its name as part of the Alca Group. It is the largest manufacturer of sanitary ware in Central and Eastern Europe, producing more than 600 sanitary ware products on the area of over 60,000 m² - valves, traps, WC systems, shower drains, floor drains, toilet seats and other products.



alcapipe

Piping systems

The company FV - Plast was founded in 1990 with the aim of producing quality plastic piping systems for water distribution and heating. In 2021, it became part of the Alca Group and will bear the name Alcapipe in the future. After more than 30 years of production, development and innovation, it now processes polyethylenes, polypropylenes and polybutylenes into many types of pipes, fittings and accessories. It is the largest manufacturer of PP-RCT pipes and fittings in Central and Eastern Europe.

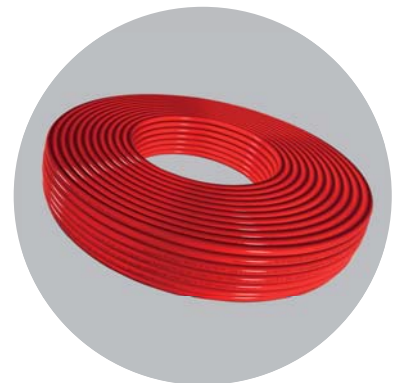
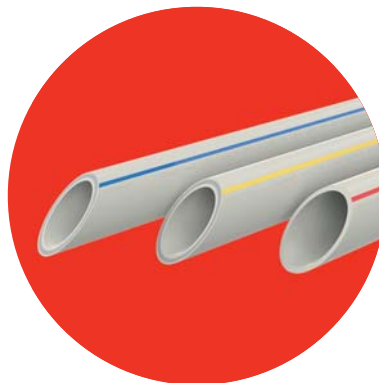

alcafix

System walls

Alcafix was established in 2022 within the Alca Group. It deals with the production of modular systems for the construction and reconstruction of bathrooms and toilets. These prefabricated walls integrate Alca's sanitary technology and piping systems and are used both in larger development projects and in the construction of family houses or reconstructions.

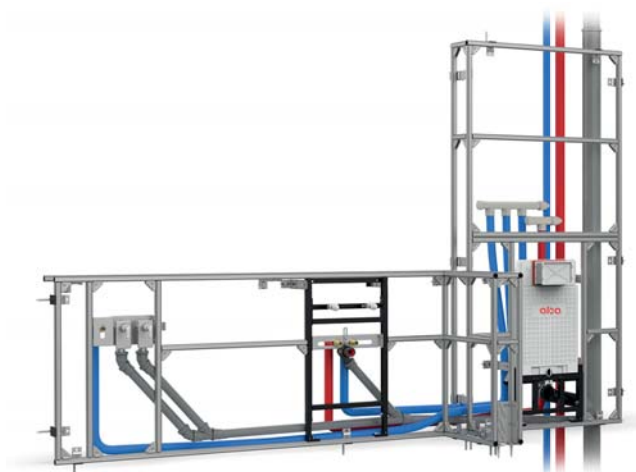

INDEX

FV PP-RCT UNI	14	FV PPR flange adaptor	27
FV PP-RCT HOT	14	FV PPR FE flange	28
FV PP-RCT FASER HOT	15	FV PPR transition union male	28
FV PPR CLASSIC - PIPE IN COIL	15	FV PPR transition union female	28
FV PPR compensation pipe	16	FV PPR transition union male with nipple	28
FV PPR crossover	16	FV PPR transition union female with nipple	29
FV PPR crossover with socket	16	FV PPR elbow 90° for wall mounting	29
FV PPR crossover with socket	16	FV PPR elbow 90° for wall mounting internal / external	29
FV PPR elbow 90°	17	FV PPR elbow 90° for wall mounting left and right	29
FV PPR elbow 90° reduced	17	FV PPR elbow with metal female thread UNI	29
FV PPR elbow 45°	17	FV PPR holder MONO for UNI elbow	30
FV PPR elbow 90° internal / external	17	FV PPR holder DUO for UNI elbow	30
FV PPR elbow 45° internal / external	18	FV PPR wall elbows with holder	30
FV PPR elbow 90° for wall mounting welding	18	FV PPR elbow for gypsum wall mounting	30
FV PPR reduction internal / external	18	FV PPR tee with tap connector	30
FV PPR three-way elbow	18	FV PPR wall mounting group with tap connectors	31
FV PPR socket	19	FV PPR wall elbow with holder	31
PPR reduction	19	FV PPR assembling plate for elbow 90° for wall mounting	31
FV PPR bend 90° int/ext	19	FV PPR electro-fusion socket	31
FV PPR bend 90°	19	FV PPR joining elbow 45° to the radiator	32
FV PPR tee	20	FV PPR joining elbow 90° to the radiator	32
FV PPR tee reduced	20	FV PPR sleeve euroconus with metal thread	32
FV PPR cross piece	20	FV PPR ball valve plastic with a butterfly / FV PPR ball valve plastic with a lever	32
FV PPR reducing sleeve with plastic male thread	21	FV PPR radiator ball valve straight	33
FV PPR tap elbow for welding internal	21	FV PPR radiator ball valve elbow	33
FV PPR threaded tap connector (fast)	21	FV PPR ball valve plastic with PV valve	33
FV PPR blinding	21	FV PPR ball valve with threaded elbow for hose connection	33
FV PPR threaded tap connector	22	FV PPR valve with threaded elbow for hose connection	34
FV PPR blinding internal	22	FV PPR straight-way valve	34
FV PPR pressure plug short	22	FV PPR straight-way valve with PV valve	34
FV PP-RCT weld in saddle polyfusion	22	FV PPR back flow valve	34
FV PP washer	23	FV PPR filter	35
FV PP pressure plug long	23	FV PPR shut off valve lux straight with chrome handle	35
FV PPR elbow 90° with metal male thread	23	FV PPR shut off valve straight with cover	35
FV PPR reducing sleeve with metal male thread	23	FV PPR inside the valve	35
FV PPR reducing sleeve with metal female thread	24	FV PP-RCT butt welding elbow 90°	36
FV PPR elbow 90° with metal female thread	24	FV PP-RCT butt welding elbow 45°	36
FV PPR weld in saddle with metal male thread	24	FV PP-RCT butt welding reduction	36
FV PPR weld in saddle with metal female thread	25	FV PP-RCT electro-fusion socket	36
FV PPR reducing sleeve with metal female thread with cross	25	FV PP-RCT butt welding tee	37
FV PPR tee with metal female thread	25	FV PP-RCT polyfusion/butt welding tee reduced	37
FV PPR tee with metal male thread	25	FV PP-RCT butt welding blinding	37
FV PPR metal reducer with cap nut	26	FV PP-RCT weld in saddle polyfusion	37
FV PPR union plastic / brass unwelded	26	FV PP-RCT weld in saddle with metal male thread polyfusion	38
FV PPR plastic reducing sleeve with cap nut	26	FV PP-RCT weld in saddle with metal female thread polyfusion	38
FV PPR coupling with nut	27	FV PP-RCT butt welding flange adaptor	38
FV PPR elbow 90° plastic reducing sleeve with cap nut	27	FV PP-RCT flange plastic covered	38
FV PPR tee plastic reducing sleeve with cap nut	27		

Welding machine 650 W for non-paired adapter ø16 - ø63	40	FV M-PRESS shut off ball valve lux straight with chrome handle.....	59
Welding machine 850 W for paired adapter ø16 - ø75	40	FV M-PRESS shut off ball valve straight with cover	59
Dytron Welder Polys P-4 650 W	40	FV M-PRESS joining elbow 90° to the radiator	60
Dytron Welder Polys P-4 850 W	40	FV M-PRESS reducing sleeve to CU	60
Dytron Welder Polys P-4 1200 W	40	FV M-PRESS blinding.....	60
Dytron Welder Polys P-1b 500 W	41	Calibrator MULTI.....	61
Mini set SE 22.....	41	Bending pipe spring outer for FV MULTI pipes.....	61
Mini set SE 42.....	41	Bending pipe spring inner for FV MULTI pipes	61
Profi set SE 22	41	Pipe insulation Tubex (foamed PE)	63
Profi set SE 42.....	41	Adhesive tape	63
Adapter paired for SE 42 black	42	Insulation adhesive tape	63
Adapter paired for SE 42 blue	42	Insulation clip	64
Adapter paired for weld in saddle	42	Insulation felt.....	64
Drill for weld in saddle	43	O-ring Taboren	64
Adapter non-paired for SE 22 black.....	43	Teflon insulation tape.....	64
Adapter non-paired for SE 22 blue	43	Plastic clip PP	65
Repairing set	43	Plastic double clip PP	65
Repairing stake	43	Plastic clip with stirrup.....	65
Pipe cutter REMS	44	Plastic double clip with stirrup	65
Shears.....	44	Spacing clip for cold water.....	66
Tightening spanner with belt	44	Plastic clip with strap	66
Spiral for sewer cleaning.....	44	Metal sleeve	66
Assembly MP 75	44	Screw combi.....	66
Assembly MP 110 UD	45	Dowels	67
Assembly Spider 125.....	45	Threaded bar	67
Case for welding machine PROFI	45	Clamping strap	67
Case for welding machine MINI	45	Plastic trough.....	67
FV MULTIPERT-AL pipe in coil	53	Trough cover plastic	67
FV MULTIPERT-AL pipe in bars.....	53	Galvanized trough (2 m length)	68
FV MULTIPERT-AL pre-insulated pipe 6 mm in coil	53	RPE pipe.....	68
FV MULTIPERT-AL pre-insulated pipe 10 mm in coil	53	FV MULTIPERT-5	72
FV M-PRESS reducer with cap nut	54	FV MULTIPERT-AL.....	72
FV M-PRESS reducing sleeve with metal female thread	54	FV EPS insulated mounting mate in roll.....	73
FV M-PRESS reducing sleeve with metal male thread	54	FV system foil with grid	73
FV M-PRESS join	55	FV NOP SOLO system mat.....	73
FV M-PRESS reduction	55	FV NOP ISO system mat with 11 mm insulation	73
FV M-PRESS elbow 90°	55	FV NOP ISO PLUS system mat with 30 mm insulation	74
FV M-PRESS elbow 45°	56	FV DR system board with 30 mm insulation for dry construction	74
FV M-PRESS elbow 90° for wall mounting	56	FV DK end system board with 30 mm insulation for dry construction ..	74
FV M-PRESS running elbow 90° for wall mounting.....	56	FV DKS end system board with 30 mm insulation for dry construction	74
FV M-PRESS running elbow 180° for wall mounting.....	56	FV RENO special mat for floor reconstruction.....	74
FV M-PRESS elbow 90° with metal female thread	57	FV clamping rail	75
FV M-PRESS elbow 90° with metal male thread	57	FV staple for clamping rail	75
FV M-PRESS elbow 90° reducing sleeve with cap nut	57	FV manifold with Eurocone INOX.....	78
FV M-PRESS wall mounting group with tap connectors for gypsum walls	57	FV ball valve 1" int/ext thread	78
FV M-PRESS wall mounting group with tap connectors	58	FV thermometer for manifold	78
FV M-PRESS tee.....	58	FV mixing set.....	79
FV M-PRESS tee reduced.....	58	FV manifold cabinet on plaster.....	79
FV M-PRESS tee with metal female thread	59	FV manifold cabinet under plaster	79
FV M-PRESS tee with metal male thread.....	59	FV tacker staple.....	80
		FV edge belt.....	80

FV PE protecting tube.....	80	FV Condensation point receptor for plasterboard ceiling	94
FV expansion profile	80	FV Condensation point receptor	94
FV direction diverter "click"	80	FV electronic switching module.....	94
FV fixing plastic bend.....	81	FV Clamping bar PENTA.....	95
FV self-adhesive tape	81	FV Conductive bar R 20 for pipe 8x1mm.....	95
FV Actuator NC- Thermal drive - 230 V.....	81	FV Arc console.....	95
FV thermostatic controller	81	FV silicone paste for sealing O-circlets.....	95
FV electronic switching module.....	81	NEW BRADO	100
FV transition union to the distributor (Eurocone 3/4").....	82	ALTRA SCANDIC	100
FV coupling.....	82	SPIDER	101
FV reducing sleeve male 3/4	82	NOMO.....	102
FV plug female 3/4.....	83	REGA	102
FV Tacker - fixing gun	83	REGO.....	102
FV Tacker - fixing gun plastic.....	83	Electrofusion socket SDR 11	103
FV horizontal decoiler	83	Electrofusion blinding SDR 11	103
FV COOLING PE-RT 16x2 mm.....	89	Electrofusion reduction of SDR 11	103
FV COOLING PB 8x1 mm	89	Electrofusion bend 90° SDR 11	104
High quality matt CoolFLEX.....	89	Insert transition PE - brass female thread SDR 11.....	104
FV COOLING MATT CoolPLATE	90	Insert transition PE - brass male thread SDR 11.....	104
FV Plasterboard Thermalpanel	90	Insert transition PE - brass with nut SDR 11	105
FV PLAST MANIFOLD PUSH 16, 0,6-2,4 l/min	90	Electrofusion Y-piece - reducing the number of branches.....	105
FV PLAST MANIFOLD PUSH 16, 1-4 l/min.....	91	FV ENERGEO GH 12,5.....	105
FV MANIFOLD PUSH 16, 2-8/min	91	FV ENERGEO GH 16	106
FV Spherical valve for dividers 6/4"-1"	92	FV ENERGEO GH DUO 12,5	106
FV T-transitional quick coupling.....	92	FV ENERGEO GH DUO 16	106
FV direct quick coupling	92	FV ENERGEO CP HDPE 100RC PN 10	107
FV Angular tube - quick coupling.....	92	FV ENERGEO CP HDPE 100RC PN 12,5.....	107
FV Transition.....	92	FV ENERGEO CP HDPE 100RC PN 16	107
FV Blinder (sealing)	93	Electrofusion welder with barcode reader	108
FV Reinforcing sleeve 16 x 2 mm	93	Weight	108
FV Actuator NC- Thermal drive - 230 V.....	93	FV HDPE 100 RC SDR 11	114
FV Manual areal thermostat FV COOLING.....	93		
Condensation point receptor	94		

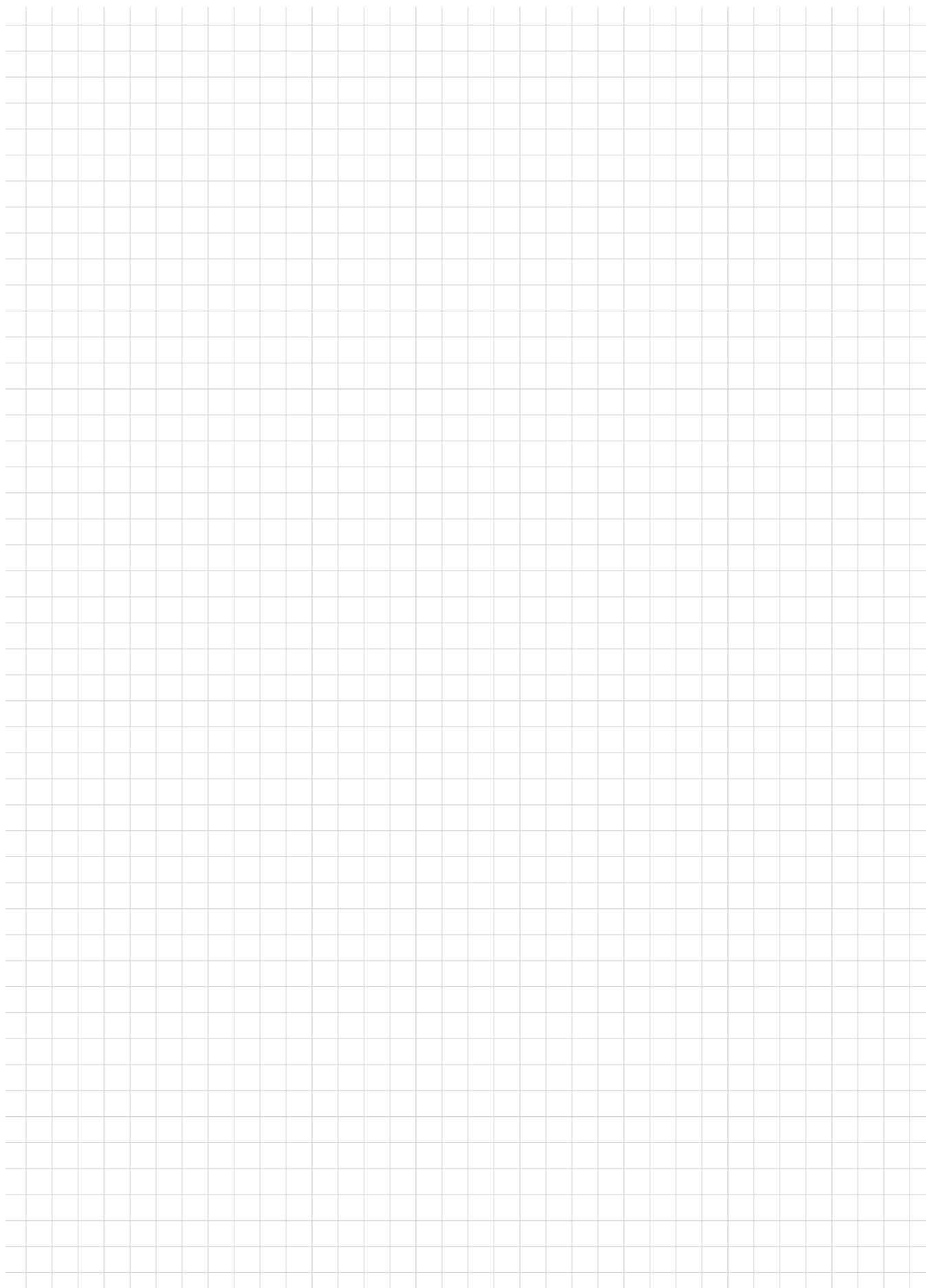

alca GROUP

alcadrain

Sanitary systems

Czech Republic
Alcadrain s.r.o.
Komunardů 1626/35
170 00 Prague 7 – Holešovice
T: +420 519 821 117 –
sale in the Czech Republic
+420 519 821 041 – export
alcadrain@alcadrain.cz
www.alcadrain.com

alcapipe

Piping systems

Czech Republic
FV – Plast, a.s.
Kozovazská 1049/3,
250 88 Čelákovice
T: +420 326 706 711
fv-plast@fv-plast.cz
www.fvplast.com

alcafix

System walls

Czech Republic
Alcadrain s.r.o.
Komunardů 1626/35
170 00 Praha 7 – Holešovice
alcafix@alcafix.cz
www.alcafix.cz

The ALCA team of specialists is always on hand to help with design, installation and quote project prices!



Czech manufacturer
Edition 1/2023 EN, © FV - Plast, a.s.
Dimensions and design are subject to change.